

Local Development Framework

Accessible Hillingdon

**Supplementary Planning Document
(Revised Draft August 2009)**

Planning and Community Services

www.hillingdon.gov.uk



HILLINGDON
LONDON

1 Foreword	2
2 Introduction	3
3 Legislation and Guidance	4
4 Policy	5
5 Residential Development	8
6 Lifetime Home Standards	9
7 Key features of a Lifetime Home	10
8 Wheelchair Home Standards	20
9 Minimum Floorspace Standards	30
10 Sheltered housing / Residential developments for over 65's	35
11 Public, Commercial and Employment Development	36
12 Specific Building Types	67
13 Access Statements	73
14 National Planning Policy Statements and Guidance	76
 Appendices	
15 Best Practice Sources and References	79
16 Glossary	80

1 Foreword

Hillingdon Council recognises that Planning and Building Control are central to our goal to create buildings, spaces and places that allow everyone to use facilities and services on a level playing field, regardless of personal circumstance: pregnancy, injury, period of ill health, disability, moving around with children or simply as people get older.

‘Accessible Hillingdon’ builds on the policy and legislation now in place, and aims to assist professionals involved in shaping the built environment to identify design solutions that support the everyday needs and lifestyles of our diverse community.

As we work towards creating a borough that is welcoming to everyone, Hillingdon Council is committed to ensure that accessibility is not a mere gesture, but an absolute requirement of designers and developers to ensure that good design is embedded into the infrastructure of the community. With this in mind, the Council will only encourage development where access and high-quality design is interwoven and based on standards compatible with 21st Century living.

We look forward to early engagement and continued teamwork with all professionals involved in the development process who embrace the principle and spirit of inclusive design.

Councillor Keith E Burrows,
Portfolio Holder, Planning & Transportation.



2 Introduction

A truly inclusive environment materialises only when the finer points of access and inclusion have been part and parcel of the initial design brief and continuously re-evaluated throughout the detailed design stage of a development. Development applications where access for disabled people is an obvious 'bolt-on', or where it has otherwise been poorly considered, will invariably slow the planning process and may result in planning refusal on those grounds alone.

'Accessible Hillingdon' echoes various Codes of Practice pertinent to the design of inclusive environments, and in many instances goes beyond minimum Building Regulation requirements. It offers practical and technical best practice guidance to enable planning applicants, developers, architects, urban designers, and other professionals to adopt a tangible approach to Inclusive Design.

Accessible Hillingdon is supplementary to Hillingdon UDP (Unitary Development Plan) Saved Policies R16 and AM13, London Policies 3A.5, 4B.1 and 4B.5, and the emerging LDF (Local Development Framework), and is a material consideration in determining the outcome of planning applications.

DRAFT

3 Legislation and Guidance

Part M to the Building Regulations

Building Regulations Approved Document M (2004 edition) sets minimum standards to enable people to access and use buildings with ease. The regulations cover public buildings and new dwellings.

BS 8300 : 2009 – Code of Practice

BS 8300 : 2009 provides best practice guidance on the design of buildings and their approaches to meet the needs of disabled people. The document covers domestic and non-domestic buildings and goes beyond the minimum requirements of the Building Regulations.

The Disability Discrimination Act 1995 (amended 2005)

The DDA gives disabled people particular rights in the areas of education, employment, access to goods, facilities and services and buying or renting land or property. The Act makes it unlawful for employers and service providers to treat people less favourably on the grounds of their disability. The duty may require the removal or modification of a building or service, to allow access by disabled people.

Special Educational Needs and Disability Act 2001

SENDA 2001 (amended Part 4 of the DDA) legally entitles disabled pupils and prospective pupils to learn in an environment which is barrier free and where discriminatory practices have been eliminated. The Act places a duty on Local Education Authorities and schools to systematically plan and implement access improvements to school buildings and other educational facilities. Colleges and universities are obligated to provide accessible services and auxiliary aids and may be required to make physical alterations to a building.

The Planning and Compulsory Purchase Act 2004

The Act modified procedures in development planning and control to include a number of provisions relating to Access Statements.

British Standard 9999

BS 9999 builds on legislation to provide an advanced approach to fire safety in the design, management and use of buildings, with particular reference to means of escape for disabled people. *(BS 9999 supersedes DD 9999, and the entire BS 5588 series (with the exception of BS 5588-1), from 6 April 2009.)*

4 Policy

Local Policies

Policy R 16

The local planning authority will only permit proposals for shops, business use, services, community and other facilities open to the public if they include adequate provision for accessibility, in particular those of elderly people, people with disabilities, women and children. Where appropriate to the scale and nature of the development proposed, new development should include:

- i. Safe and convenient access by public and private transport and on foot;
- ii. Safe and convenient means of physical access to all floors;
- iii. Facilities for child and baby care; accessible for male and female carers, and
- iv. Toilets accessible to people with disabilities and have regards to the measures set out in policies AM13 (i) - (iv) and R17.

Policy AM 13

The local planning authority will seek to ensure that proposals for development increase ease and spontaneity of movement for elderly people, the frail and people with disabilities by including where appropriate:

- i. improved dial-a-ride and mobility bus services together with suitable means for people with disabilities and people dependent on wheelchairs for mobility to use public transport;
- ii. shopmobility schemes;
- iii. adequate and convenient parking spaces for people with disabilities, especially around shopping areas and entertainment and recreation facilities;
- iv. measures to incorporate the needs of people with disabilities into road, footway, parking and pedestrianisation schemes; including benches, public lavatories, footpath surfaces, dropped kerbs and textured crossings, with proper regard to the siting and visibility of street furniture.

London Plan Policies**Policy 3A. 5****Housing choice**

Boroughs should take steps to identify the full range of housing needs within their area. DPD policies should seek to ensure that:

- i. new developments offer a range of housing choices, in terms of the mix of housing sizes and types, taking account of the housing requirements of different groups;
- ii. all new housing is built to 'Lifetime Homes' standards;
- iii. ten per cent of new housing is designed to be wheelchair accessible, or easily adaptable for residents who are wheelchair users.

In undertaking an assessment of housing needs, a borough should consult fully and ensure that the assessment includes the full range of different communities within the borough, such as black and minority ethnic communities, disabled people, older people and households with specialist or different requirements, and that such communities are consulted on how policy is derived from the needs assessment.

Policy 4B. 1**Design principles for a compact city**

The Mayor will, and boroughs should, seek to ensure that developments should:

- i. maximise the potential of sites;
- ii. promote high quality inclusive design and create or enhance the public realm;
- iii. contribute to adaptation to, and mitigation of, the effects of climate change;
- iv. respect local context, history, built heritage, character and communities;
- v. provide for or enhance a mix of uses;
- vi. be accessible, usable and permeable for all users;
- vii. be sustainable, durable and adaptable in terms of design, construction and use (see Chapter 4A);
- viii. address security issues and provide safe, secure and sustainable environments (Policy 4B.6);
- ix. be practical and legible;
- x. be attractive to look at and, where appropriate, inspire, excite and delight;
- xi. respect the natural environment and biodiversity, and enhance green networks and the Blue Ribbon Network;
- xii. address health inequalities (Policy 3A.23).

Policy 4B. 5

Creating an inclusive environment

The Mayor will require all future development to meet the highest standards of accessibility and inclusion. DPD policies should integrate and adopt the principles of inclusive design so that developments:

- can be used safely, easily and with dignity by all regardless of disability, age, gender, ethnicity or financial circumstances;
- are convenient and welcoming with no disabling barriers, so everyone can use them independently without undue effort, separation or special treatment;
- are flexible and responsive taking account of what different people say they need and want, so people can use them in different ways
- are realistic, offering more than one solution to help balance everyone's needs, recognising that one solution may not work for all.

The principles of inclusive design should be used in assessing planning applications and in drawing up masterplans and area planning frameworks. Design and access statements should be submitted with development proposals explaining how the principles of inclusive design, including the specific needs of disabled people, have been integrated into the proposed development and how inclusion will be maintained and managed.

The principles of inclusive design and the requirements of Policy 3A.17 should be adopted by all responsible for changing or managing the built environment.

Regional Planning Policy

The London Plan (Consolidated with alterations since 2004), GLA (February 2008)

A key objective of the London Plan is to build a London that achieves the highest standards of safe, easy and inclusive access for all people, regardless of disability, age or gender. The plan includes requirements for all new housing to be accessible.

Accessible London: Achieving an Inclusive Environment, GLA (April 2004)

The supplementary planning guidance set out in Accessible London provides detailed information on the London Plan policies.

5 Residential Development

Hillingdon Council has adopted Lifetime and Wheelchair Home Standards in line with London Plan Policy 3A.5 to provide homes that are accessible and flexible in their appeal and application.

Lifetime Home Standards and also wheelchair accessible housing is a planning requirement. Full details of a proposed development, including the external design features, should be submitted with a planning application. Floor plans should include turning circles in context to a typical furniture layout, to demonstrate sufficient manoeuvring space exists for wheelchair users.

All new residential development must:

- adhere to the GLA minimum floorspace standards
- be designed to Lifetime Home Standards;
- in developments comprising 10 or more dwellings, have 10% designed to Wheelchair Home Standards.

These standards are applied to all types of dwelling, in both the private and affordable housing sectors. They also apply to:

- conversions, e.g. a house into flats;
- change of use applications;
- the residential element of a Live Work scheme.

It may not be feasible to incorporate the standards into some existing buildings, in which case the reason(s) should be justified within the accompanying Access Statement (see page 70).

N.B. Hillingdon Council will not look favourably upon proposed housing developments that fall below the following standards.

6 Lifetime Home Standards

A Lifetime Home is defined by 16 criteria that make residential accommodation more convenient, flexible and adaptable. Lifetime Homes are designed to be able to cope with families' changing needs. Built in features such as wide doors, level access and removable concealed wall panels become invaluable as people get older and perhaps less mobile. The design can also allow many disabled people to occupy a Lifetime Home with minor or no alteration; however, they will only suit the needs of some wheelchair users.

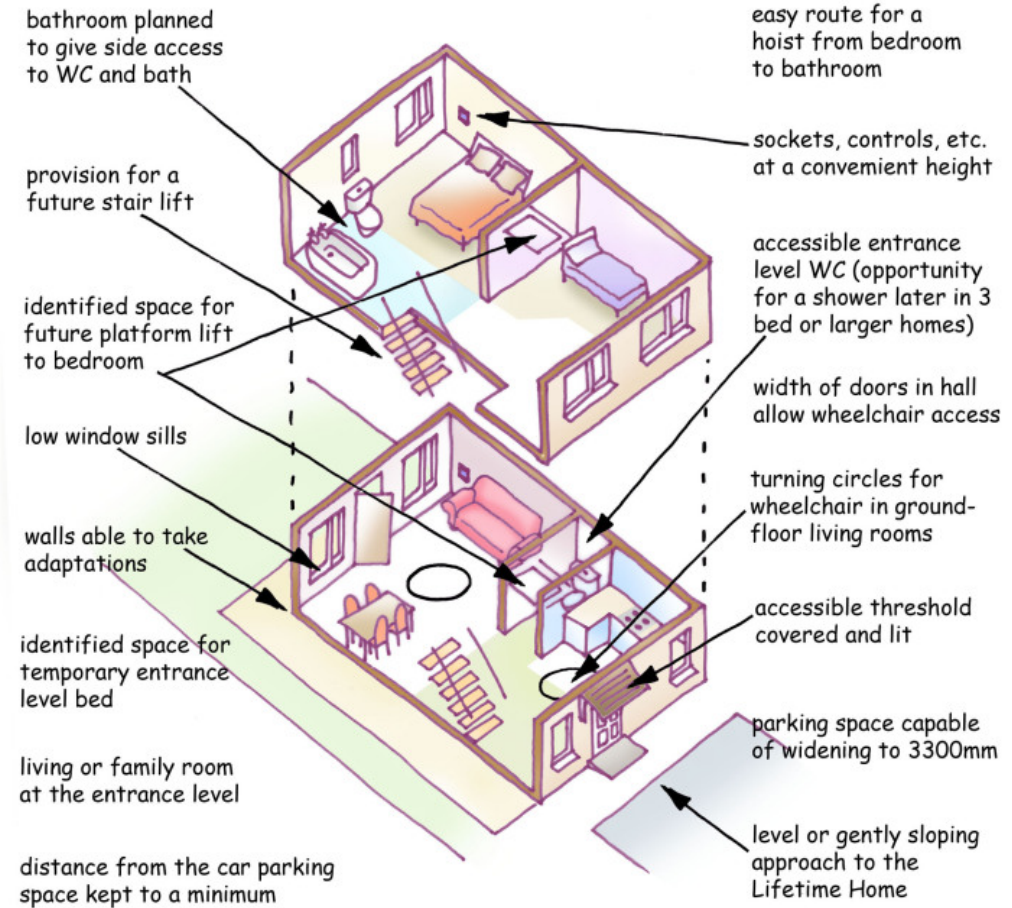

Lifetime Homes -16 Criteria

DRAFT

7 Key features of a Lifetime Home

To satisfy Lifetime Home Standards, a residential developments must ensure:

Accessible Parking

Where a parking space is provided it should be allocated to a particular dwelling.

The parking bay should:

- be 2400mm wide but capable of enlargement to 3300mm by removing a path or garden strip adjacent to the bay;
- not be marked as accessible parking;
- allow car parking as close as possible to the home;
- be allocated (i.e. numbered) to a specific dwelling.

N.B. A degree of flexibility is permitted for development comprising blocks of flats.

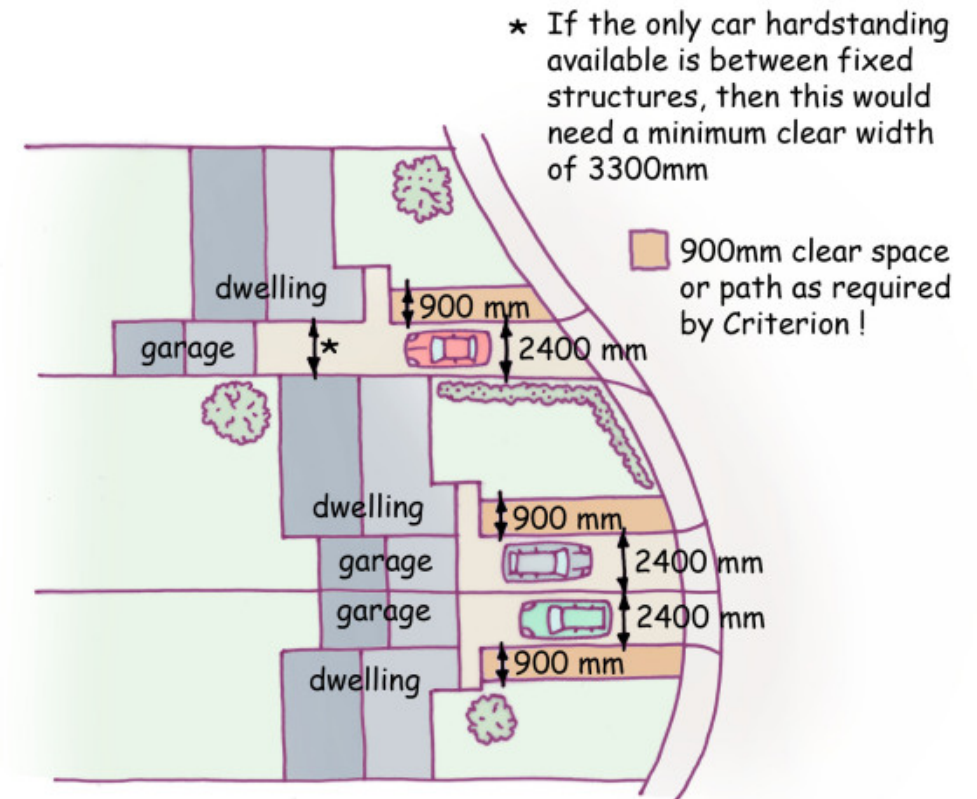

Potential for accessible parking

Approach to the Home

In most circumstances the route to the home must be:

- level or gently sloping;
- no steeper than 1:20;
- no less than 1200 mm wide, where a path or pavement leads to a communal entrance.

Where the topography or other site constraints prevent a level or gentle sloped approach, an access ramp to the home will be required (designed to Part M Standards). This measure should be employed only as a last resort and fully justified as part of an accompanying Access Statement (see page 70).

In addition, a Lifetime Home should:

- feature a setting down point close to a main entrance when it is within a block of flats;
- provide a path or pavement leading to a communal entrance that is firm, level, smooth, but slip resistant, and preferably 1800 mm wide. Dropped kerbs to be provided as necessary;
- have a path or pavement that contrasts in colour and/or tone with an adjacent surface, e.g. grass verge;
- ensure access routes are well lit and provide even luminance (minimum 10 lux) across a path surface.



Car parking close to and with level or gently sloping approach to main entrance. Main entrance covered and lit.

Entrance

All entrances to a Lifetime Home must:

- provide a clear opening width of no less than 800 mm;
- be well lit with diffused lighting between 100 and 200 lux;
- have a level access threshold (15mm maximum upstand);
- feature a carefully designed threshold and damp proof specification to eliminate ingress of rainwater and moisture;
- have a recessed matwell where a communal entrance mat is provided;
- ensure a covered main entrance, including a communal entrance to a block of flats.

A Lifetime Home should also provide:

- a 1000 mm wide communal entrance door, with a 200 mm nib on the external latch side (in addition to the 300 mm nib required on the inside);
- additional illumination for locks and access control points;
- level landings of 1500 x 1500 mm outside communal entrance doors;
- outside an individual dwelling, a level landing of 1200 x 1200 mm;
- door entry systems (where provided) at a height of 1000 - 1200 mm from the finished ground surface, and 200 mm from the latch side of the door frame.

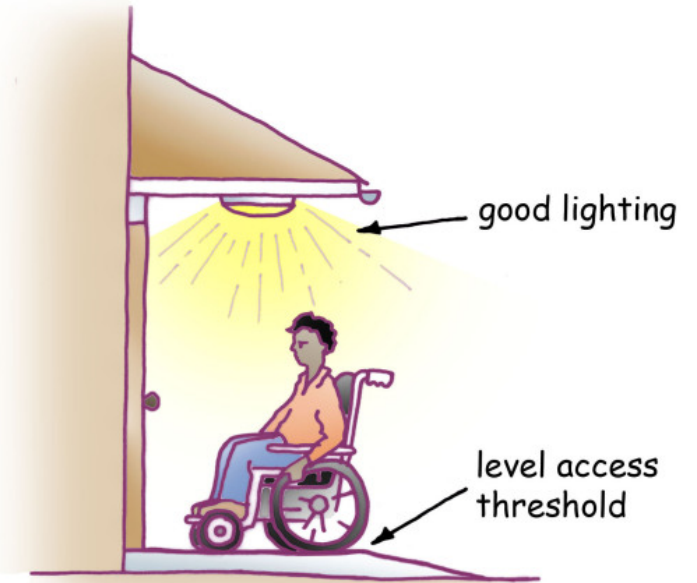

Communal Areas

Lifetime Home blocks of flats must:

- have entrance doors, lifts and stairs on or visible from the front elevation;
- feature corridor widths of at least 1500 mm;
- be accessible by passenger lift (1100 mm x 1400 mm and fitted in accordance with Part M to the Building Regulations) in blocks containing up to 15 flats;
- be served by two Part M compliance passenger lifts in blocks containing more than 15 flats;
- communal stairs designed in accordance with Part M;
- incorporate facilities that enable wheelchair users to evacuate independently. Facilities should typically include refuge areas with communication points and at least one lift that can be used during a fire.

In blocks containing five flats or less, the Local Planning Authority will invoke its discretion not to require a Part M compliant lift. To enable future wheelchair access to a Lifetime Home on an upper storey in such situations, the design of communal areas should allow for an enclosed platform lift to be installed at a later date.

Communal areas in addition should provide:

- 1000 mm wide communal hallway doors;
- a 200 mm nib on the push side of all internal communal doors.

Horizontal Circulation and Space Within a Lifetime Home

The width of doors, halls and landings should comply with the table below:

Doorway Clear Width (Minimum)	Doorway Approach	Corridor Width (Minimum)
750 mm	Head-on	900 mm
750 mm	Not Head-on	1200 mm
775 mm	Not Head-on	1050 mm
900 mm	Not Head-on	900 mm

In addition, a Lifetime Home must ensure that:

- the front door achieves a clear width no less than 800 mm;
- external and internal doors require an opening force no more than 30 Newtons from 0° (the door in the closed position) to 30° open, and not more than 22.5 Newtons from 30° to 60° open;
- doors have a 300 mm nib to the side of the leading edge (latch side of a door);
- a 1500 mm diameter wheelchair turning circle (or 1400 mm by 1700 mm ellipse) is provided in living and dining rooms;

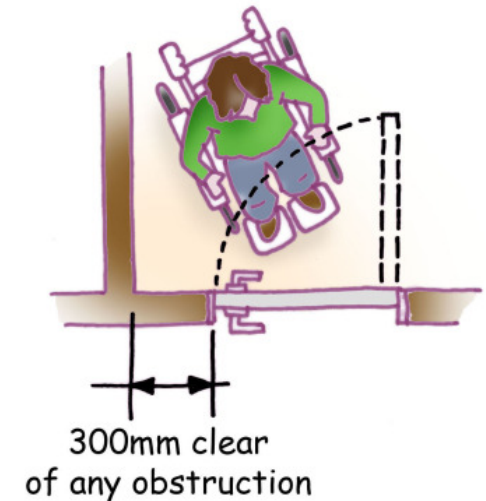

...continues overleaf

- a minimum of 1200 mm width from kitchen units to a wall or fixture opposite;
- a living room is provided at entrance level;
- there is convenient space on the ground floor that could be used as temporary bed space;
- the design provides a reasonable route for a ceilingtrack hoist between a main bedroom and bathroom. A bedroom en suite to a bathroom, or accessible via a removable floor-to-ceiling wall panel, will be expected in larger lifetime homes.

Lifetime Homes should also provide:

- a 1500 mm turning circle in the kitchen or 1700 x 1400 mm ellipse that may encroach on any clear space below worktops.

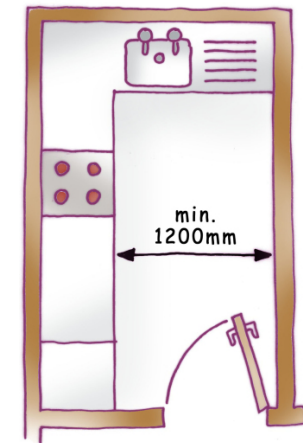
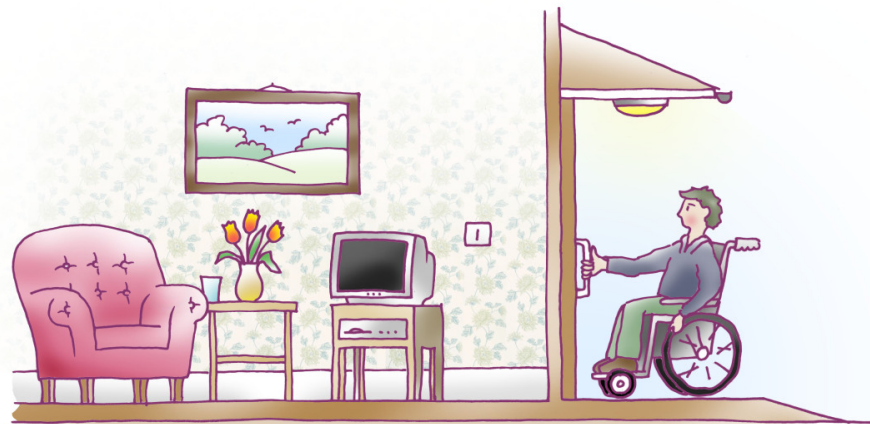

Vertical Circulation Within a Lifetime Home

A Lifetime Home with more than one storey must feature:

- stairs with a minimum 900 mm width, clear of rails and balustrade, to accommodate a future stairlift. An area of 900 mm x 400 mm should be provided at the top and bottom of a staircase;

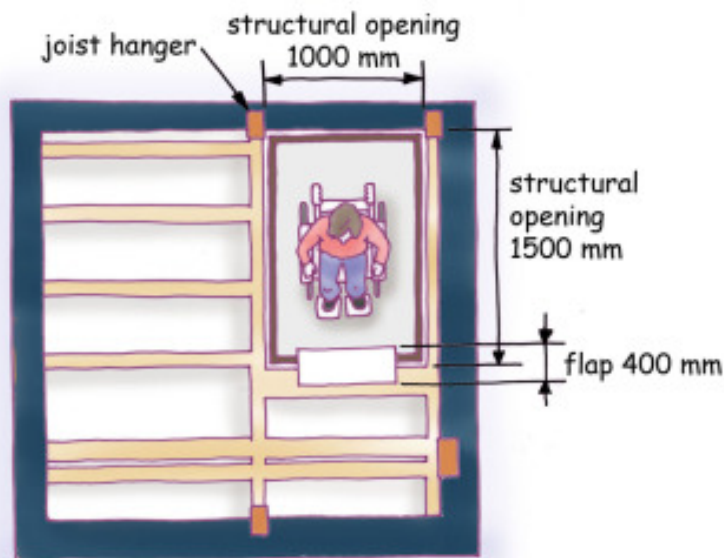

- a viable position for a future through-floor wheelchair lift that is identified, shown and technically specified on plan. (Ceiling joists should be trimmed to provide a 1500 mm x 1000 mm opening, positioned to enable firm mounting of a lift-car and vertical travel rails to a solid wall.)

N.B. Where a new staircase is proposed in conversions (e.g. a house into flats), a flight designed in accordance with Part M to the Building Regulations will be required.



WC & Bathroom Layout & Facilities

Lifetime Homes must:

- feature an entrance level WC with floor gully drainage for future shower installation. In dwellings on more than one floor, 700 mm to one side and 1100 mm of clear space in front of the toilet pan is required;
- ensure that walls in bathrooms and WCs are sufficiently reinforced, within 300 mm and 1500 mm from the floor, to allow secure fitment of adaptations that are subjected to significant load, e.g. grab handles;
- provide, in all bathrooms, a toilet pan with 700 mm to one side and 1100 mm between the front rim and a basin, wall or door opposite
- provide a 1500 mm turning circle if the bath is removed and replaced by a level-access shower that utilises the pre-installed floor gully.

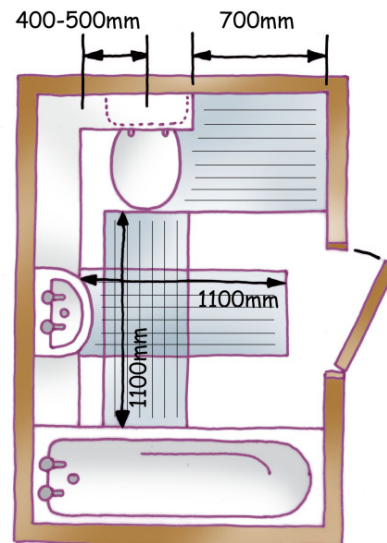

Lifetime Home bathroom

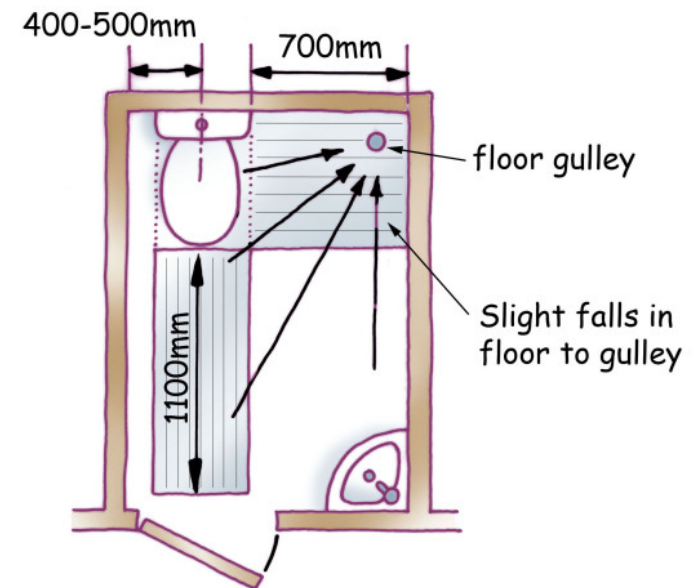

Entrance Level WC in Lifetime Homes greater than one storey

DRAFT

Fixtures and Fittings

Lifetime Homes should ensure that:

- living room window glazing begins at a maximum height of 800 mm from the finished floor level;
- window handles locks are easy to use and operable using one hand;

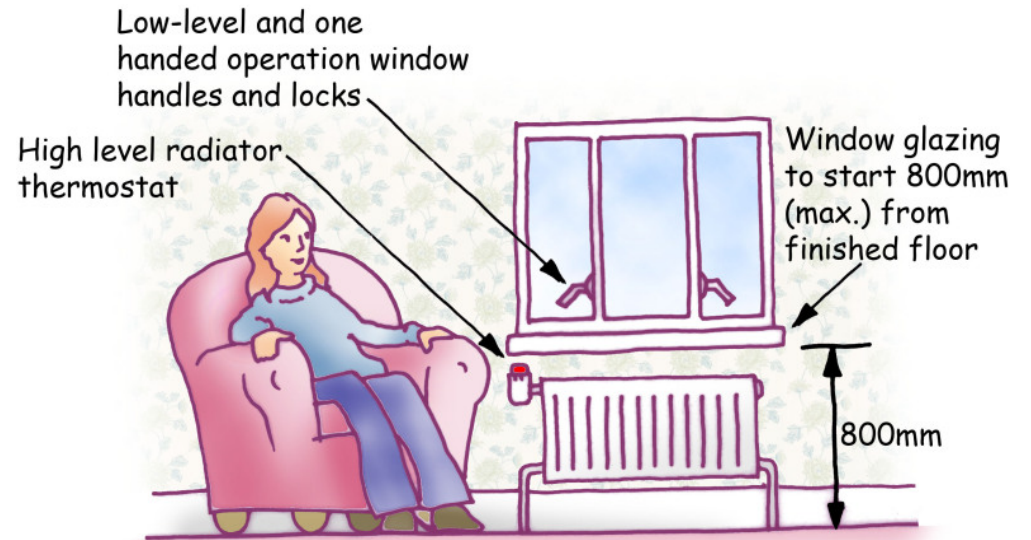

- switches, sockets, ventilation & service controls are sited between 450 mm & 1200 mm from the finished floor level;
- electrical sockets are switched at outer end;
- a high-level fused spur is provided above all doors leading outside, to enable future installation of electric door openers.

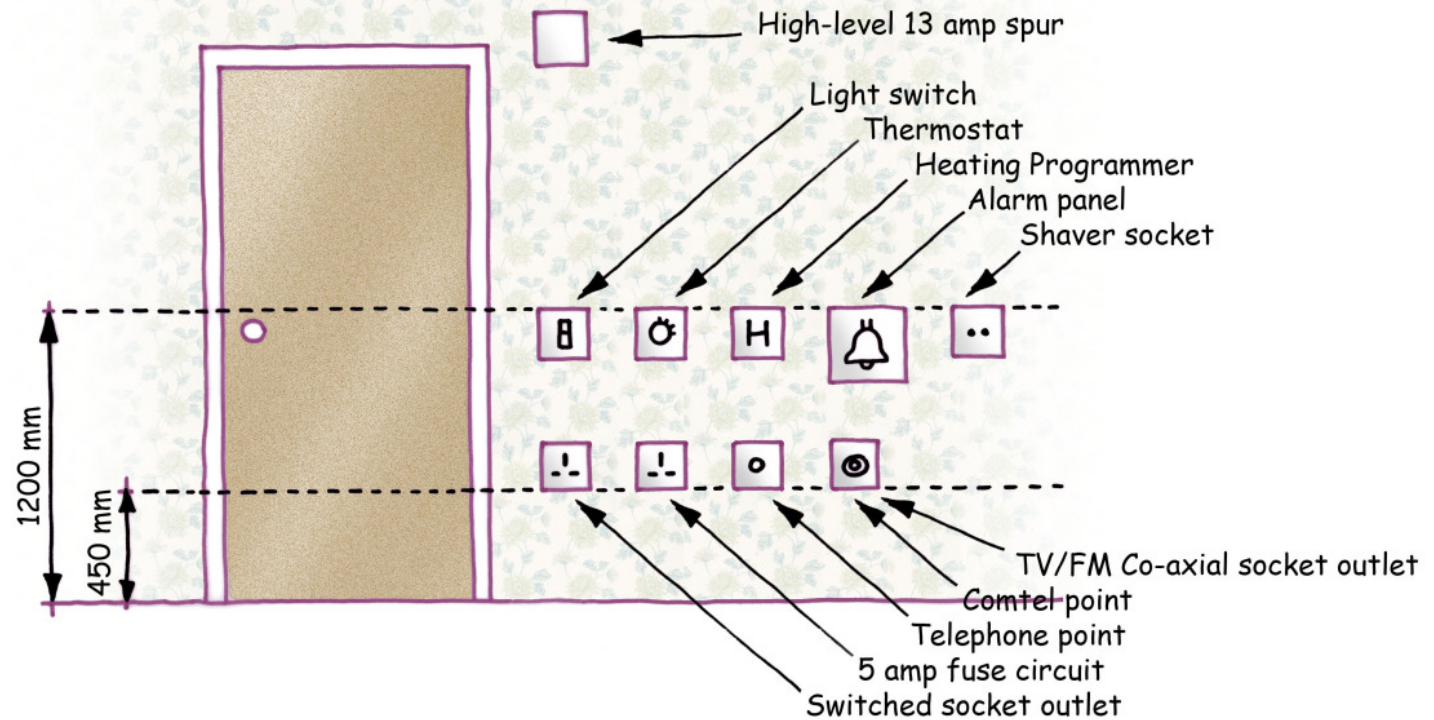

DR

8 Wheelchair Home Standards

A wheelchair accessible home exceeds Lifetime Homes Standards. A home designed for wheelchair users need not be oversized, but its design should permit unhindered mobility, including appropriate through-floor lift access in dwellings on more than one level. Wheelchair Home Standard dwellings are required for sale on the open market, as well as through affordable housing schemes.

To promote social inclusion and avoid the possibility of creating 'disability ghettos' or targeted hate crime, Wheelchair Home Standard dwellings should be evenly distributed (including within blocks of flats) throughout a development.



Key Features of a Wheelchair Standard Home

1. A covered car parking space.
2. Level hard standing with a minimum drainage fall to allow safe transfer between car and wheelchair.
3. A car park location that allows natural surveillance.
4. Car parking (where a car port cannot be provided within the curtilage) no more than 40m away.
5. Hard surfaced external paths which are non-slip, easy to maintain, hard wearing and adequately drained.
6. Good external lighting on pathways and in parking areas adequate wheelchair accessible refuse disposal areas easy to maintain garden areas screened washing drying areas (where residents do not have access to individual gardens).
7. A rear patio area, leading from a secondary garden carefully designed damp proof specification and level entrance to prevent ingress of moisture and rainwater.
8. A well ventilated storage space (1200mm x 1200mm x 700mm) for outdoor mobility vehicles with an unobstructed transfer area.
9. Hallways to be a minimum width of 1200mm.
10. Internal doors to open more than 90 degrees.
11. The leading edge of internal doors to be 550mm a minimum of 300mm from an adjacent wall.
12. A bathroom (2400mm x 2400mm) provided en-suite to a main bedroom.
13. The kitchen to have a minimum clear space (1500mm x 1500mm) between walls and/or fixed units.
14. A kitchen designed to allow safe and convenient use by wheelchair users, with worktops that are electronically or manually height adjustable.
15. A storage cupboard for disability related equipment.
16. A separate dining room or defined dining space, with adequate circulation routes.
17. Electrical sockets positioned 750mm above floor level and at least 600mm from a wall intersection (except where electrical safety standards specify otherwise).
18. A telephone point in the living room, main bedroom and second bedroom, with an adjacent plug point.

Parking

In addition to Lifetime Home requirements, parking provided for Wheelchair Home Standards units must:

- be located to allow natural surveillance to minimise risk of crime;
- provide a well designed and appropriate shelter to allow a disabled person to remain dry whilst transferring in and out of a vehicle;
- provide a 2400 x 4800 mm parking space with an adjacent 1200 mm side transfer area;
- ensure headroom of at least 2200 mm in basement or undercroft car parks;
- feature access control to any car park gates and barriers that can be operated without a disabled motorist needing to leave their vehicle;
- where parking is provided in open locations, feature a protection wall or fence adjacent to a Wheelchair Home Standard bay;
- be within 40 m of the home, where it is not feasible to provide parking within the curtilage, i.e. flatted developments;
- in car free developments, include as part of the Access Statement, a parking provision assessment for Wheelchair Home Standard units by the Council's Transportation Team .



Approach to the Home

In addition to Lifetime Home requirements, a wheelchair standard home must provide:

- a level or gentle slope (max 1:20 gradient) to all entrances, including wheelchair access to external facilities such as storage, parking, garden and washing areas;
- a slip resistant and smooth pathway leading to the dwelling(s), with a 1200 mm minimum width, and a maximum 1:50 crossfall;
- a well lit (covered if appropriate) area or route that is complimentary and intergral to the site layout and aesthetics;
- where featured, ensure a pathway gate provides a minimum clear opening width of 850 mm;
- outdoor storage 1200 x 1200 x 700 mm with an internal mains point for recharging a mobility pavement vehicle (can be provided within a Wheelchair Home Standard flat). In both cases, passive or mechanical ventilation must be ensured;
- a safe means of escape for wheelchair users from a rear door on to a patio and to a main path leading away from the home;
- consider more than one step-free access route into blocks of flats located above ground floor level.

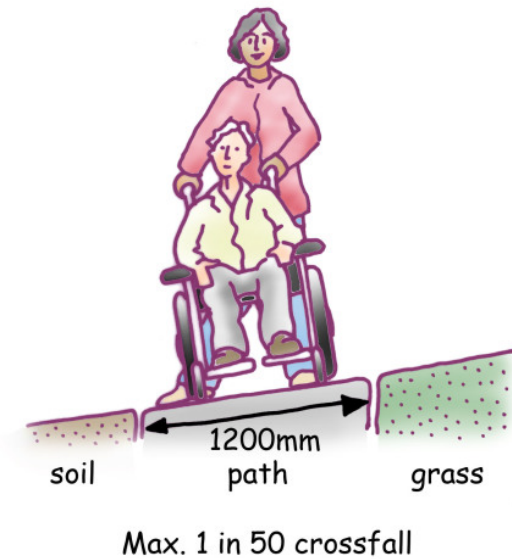

Entrance

In addition to the entrance requirements for a Lifetime Home, Wheelchair Home Standards require:

- an entrance landing to be level, and min 1500 mm x 1500 mm;
- manual switches and passive infra-red sensors to control additional external lighting from within the home;
- from the internal face of the front door, an obstruction free lobby not less than 1500 mm wide and 1800 mm to any door or wall opposite;
- a safe means of escape for wheelchair users from a rear door on to a patio and to a main path leading away from the home;

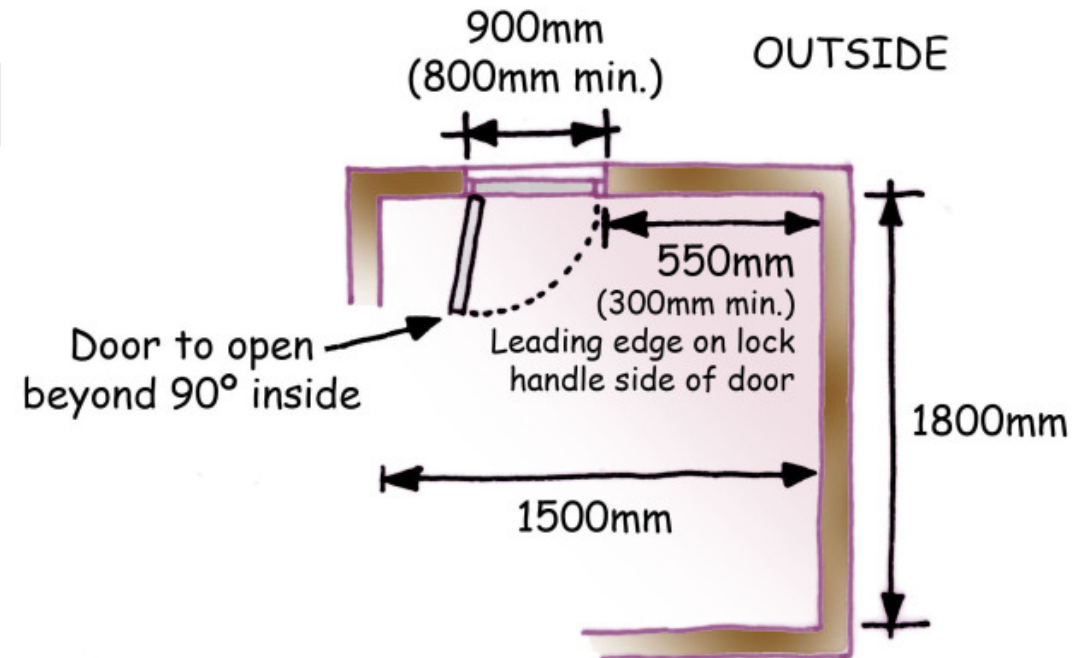

Horizontal Circulation Within the Home

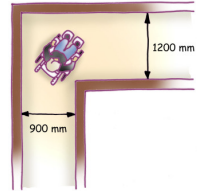
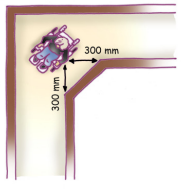
Hallway width (before turn)	Turn	Corridor Width (after turn)	
900m	Straight	900m	<p>Over and above the requirements of a Lifetime Home, a wheelchair accessible dwelling must:</p> <ul style="list-style-type: none"> ensure hallway widths adhere to the table opposite; feature internal doors with a minimum clear width of 850 mm, which open more than 90 degrees (to ensure door handles do not project into the opening); where a hallway is only 900 mm, ensure doorways leading from provide a clear opening width of 900mm (in accordance with Lifetime Home Standards); provide storage space (in addition to wheelchair recharging space) preferably off the hallway; ensure all rooms are on one level or accessible by a through-floor-lift; enable a wheelchair user to turn through 180 degrees in bedrooms and dining rooms with furniture in place, i.e. turning circle 1.5m or ellipse 1400 mm x 1700 mm; provide, in addition to turning circles, enough circulation space for a wheelchair user to manoeuvre around typical furniture items associated with a room; provide an appropriate kitchen layout to allow wheelchair users convenient and effective use. A minimum clear manoeuvring area of 1800 mm x 1500 mm should be provided. An L-shape or open-plan kitchen is preferred.
900m	90° (no splay)	 <p>1200 mm after a 90° turn</p>	
900 mm	90° (splay 300 x 300 mm)	 <p>900 mm wide with 300 mm splay</p>	

Vertical Circulation Within the Home

Integral to the design of a Wheelchair Home Standard dwelling on more than one storey, must be provision for a through-floor platform lift that travels between a hallway and an upstairs landing:

- **affordable houses:** lift to be fitted at build stage as required;
- **private houses:** to feature a concealed structural opening for future lift installation (the opening should be documented in the house buyer's pack, as well as marked on the floorboards).

Wheelchair Home Standard Bedrooms

Wheelchair Home Standard bedrooms must:

- allow wheelchair access to both sides of a double bed;
- feature wardrobes (where fitted) designed and positioned to allow a wheelchair to reach easily from a side facing position;
- ensure at least one bedroom provides minimum dimensions of 4300 mm x 3600 mm;
- provide turning space 1800 mm x 1800 mm clear of bedroom furniture.

Wheelchair Home Standard Bathrooms

In addition to the specifications required for Lifetime Home bathrooms, Wheelchair Home Standards require:

- an en-suite bathroom facility next to a main bedroom (it is acceptable to provide a removable floor to ceiling wall panel for a potential en-suite in Wheelchair Home Standard units consisting of only one bathroom);
- a wheelchair accessible bathroom with minimum dimensions of 2400 mm x 2400 mm;
- facilities to allow a wheelchair user to use independently all bathroom fixtures and fittings. Bathrooms should feature an 1800 mm x 1800 mm turning circle clear of fixtures and fittings;
- provide either a wheel-in 'wet room' shower facility or a height adjustable bathtub that is compatible with ceiling-track and free-standing hoists.

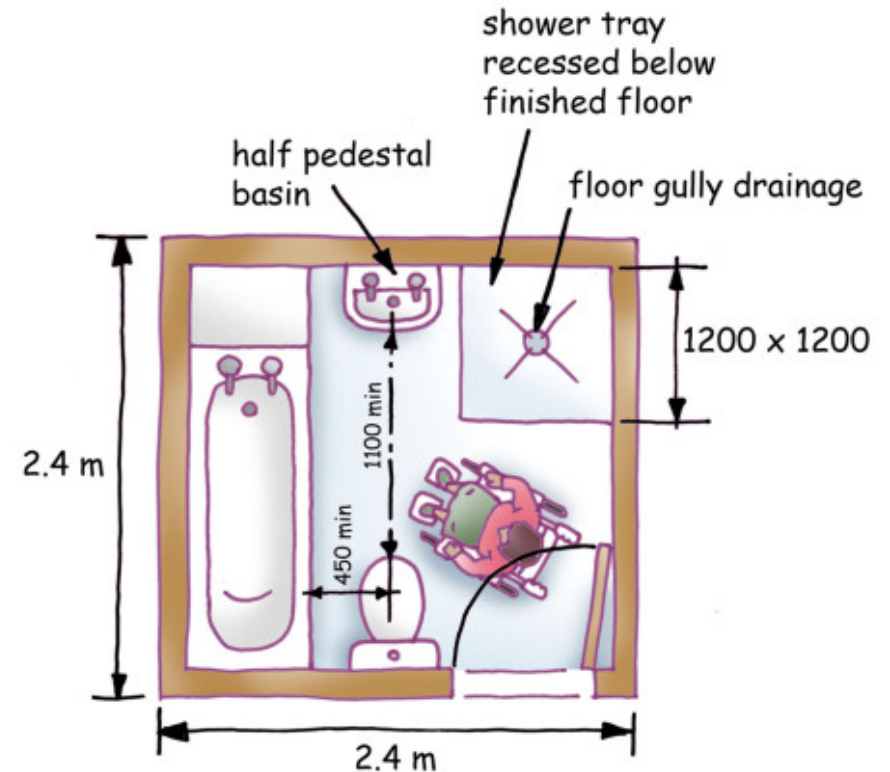

Fixtures and Fittings

In addition to Lifetime Home requirements, Wheelchair Home Standard dwellings must feature:

- easy to operate controls for mains water stopcock, gas and electricity consumer units. Isolating valves for sinks and washing machines should also be of a suitable design;
- glazing in dining and bedrooms should begin no higher than 800 mm above the floor level (avoid horizontal divisions between 800 mm and 1500 mm);
- window positions that allow for outward natural surveillance on all exposed sides of the dwelling;
- internal doors with lever-type handles at a height of 800 mm to 1000 mm;
- in bedrooms, TV aerials, telephone and power sockets and door entry system controls close to a likely bed position (consider multiple sockets to take account of various room layouts);
- plug points at a height of 750 mm from the finished floor level;
- central heating and hot water controls no higher than 1200 mm from the finished floor level;
- a high level 13 amp spur adjacent to all windows and internal doors to allow future installation of electric openers.

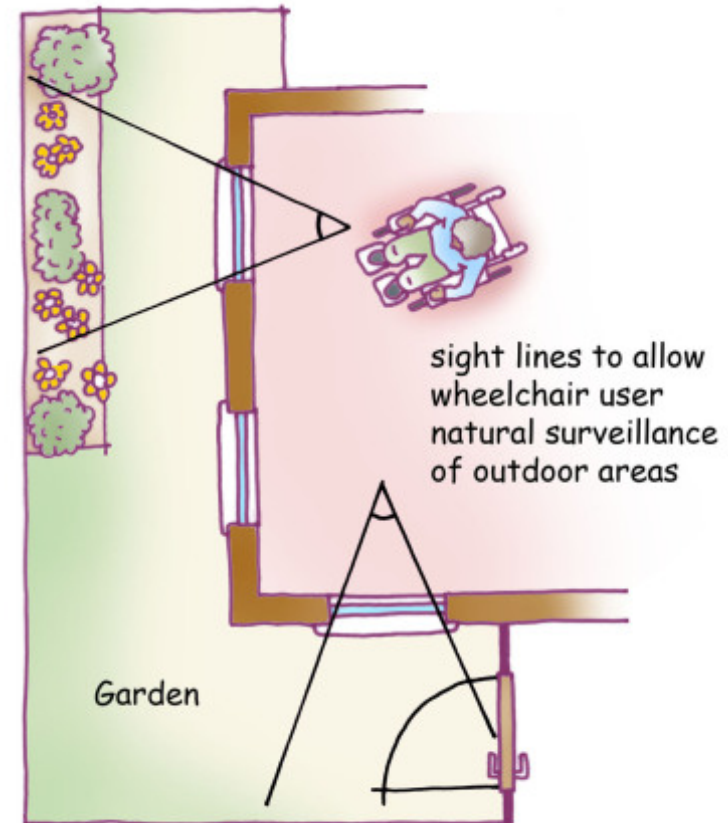

9 Minimum Floorspace Standards

Minimum floorspace standards ensure adequate space is provided in residential dwellings to achieve a pleasant, healthy home. The following standards are based on the Greater London Authority 'Housing Space Standards' report, August 2006. The following minimum floorspace standards will be applied to all residential development:

Number of bedrooms	Persons/ bedspaces	Lifetime Homes standards (m ²)	Wheelchair accessible units (m ²)
Studio/ bedsit	1	37	(generally not considered suitable for wheelchair access)
1 bed	1	51	56
1 bed	2	53	57
2 bed	3	67	77
2 bed	4	77	82
3 bed	4	84	96
3 bed	5	93	126
4 bed	5	95	130
4 bed	6	106	137
5 + bed	6	108	140
5 + bed	7	115	Over 140

Recommended minimum floor space standards

Notes:

1. Balconies are to be treated as external amenity space not as part of internal space calculations.
2. Garages should not be included in the calculation of floorspace
3. Affordable housing should be guided by the Housing Corporation's floor space standards.
4. Where new flats or rooms to new flats, including kitchens and bathrooms/ WC are proposed in the roofspace, only the internal floorspace where the headroom height is above 1.9 metres shall be counted as being usable for the purposes of satisfying the Councils internal floorspace standards.
5. All floorspaces should be net internal calculations.
6. Although the above standards are minimum requirements, applicants should seek to provide larger floor areas in developments, where possible.
7. The recommended floor space standards should include the metres squared (m²) requirements for kitchens, living and dining rooms.

The GLA Housing Space Standards Report (2006) recommends minimum floor area guidelines for specific rooms. The following standards will be applied to all residential development:

Persons/ bedspaces	Cooking, eating and living areas (CEL) (m ²)
1	22
2	22
3	24
4	27
5	30
6	33
7	36

Note:

- Cooking, eating and living areas exclude any utility area or space taken up on plan by staircases or hallways/ corridors connecting these areas
- Adequate space should be provided for wheelchair users to turn through 180 degrees with furniture in place.

Recommended standards for cooking, eating and living areas (CEL)

Bedrooms:

Aggregate bedroom areas to be no less than 7m² per single bedroom and 12m² per double/ twin bedroom provide; and Each bedroom to have a minimum internal floor area of 6.5m² for a 1 person bedroom, and 10m² for a 2 person bedroom

Notes:

- i. In larger dwellings each bedroom does not have to be at least 7m² or 12m² floor area; the designer is free to distribute the total amount of space among the bedrooms as they see fit so long as the aggregate space equates to the minimum requirements stated and the individual rooms meet the minimum requirement of 6.5m² and 10m² noted above.
- ii. Ensuite bathrooms or shower rooms do not count towards this minimum.
- iii. The floor space taken up by built in wardrobes in bedrooms counts towards the bedroom floor area
- iv. Adequate space should be provided for wheelchair users to turn through 180 degrees with furniture in place.

Bathrooms:

The floor plan dimensions for wheelchair accessible bathrooms can be found under 'Internal spaces' within this chapter.

Storage cupboards:

1m² floor area for 1person dwelling plus 0.25m² per additional person.

The minimum room dimensions (at the narrowest/ shortest point) are:

- living area: 3.2m
 - double/ twin bedroom width: 2.6m
 - bedroom length: 3m
 - habitable rooms to be no longer than twice their width, or no wider than twice their depth (i.e. the ratio 2:1 not to be exceeded)
-

"Dirty" storage (internal to the dwelling or block, or external):

- for flats without private gardens: 1m²
 - for houses bungalows and flats with private gardens for up to four people: 2.5m²
 - full houses, bungalows and flats with private gardens for five or more people: 3.0m²
-

Internal play space:

- Nothing for the first two occupants and then 2m² for each additional person.
-

Balconies:

- 3m² for 1 person or 2 person dwellings plus 1m² per additional person
-

Further guidance on density, sunlight and daylight, privacy, amenity, playspace and public open space and other design criteria is provided in the Hillingdon Design and Accessibility Statement (HDAS): Residential Layouts Supplementary Planning Document.

10 Sheltered housing / Residential developments for over 65's

New homes specifically for the above groups in both public and private sectors, must comply with Lifetime and Wheelchair Home Standard requirements, and must:

- Provide Part M compliant lifts to all upper floors, regardless of building size or number of units;
- bathrooms and WCs to be fitted with grab rails and external override door lock;
- an induction loop system installed in communal rooms and reception areas;
- A minimum of category 5 wiring (for easy installation of personal monitoring and alarm systems.)

The applicant should make every endeavour to obtain an Approved Design Award under Secure by Design. More details of this can be found at: www.securedbydesign.com.

Residential Care Homes

To be built in accordance with the Care Quality Commission, National Minimum Standards, and to have regard to the best practice guidance contained in this document. For all newly built homes and first time registrations, the location and layout of the home should be suitable for its stated purpose.

- paragraphs 3.41-3.52 of Part B of the Building Regulations (Fire Safety) as amended 2007 must be met.

11 Public, Commercial and Employment Development



External Environment

Streetscape

Pavements, footways and other pedestrian routes must:

- be at least 1800 mm wide, and preferably 2000 mm;
- in less busy areas, be at least 1500mm in width;
- provide a head height of at least 2100 mm from the pavement to any overhead protrusion;
- highlight potential hazards and edges using a kerb or guardrail, or by introducing a change in surface texture and/or colour or tonal contrast;
- be level, the gradient not exceeding 1 in 20, with cross-falls no greater than 1 in 50;
- have surfaces that are slip resistant, even, firm and durable;
- be direct, well lit, and clearly defined;

Figure 1
External Route

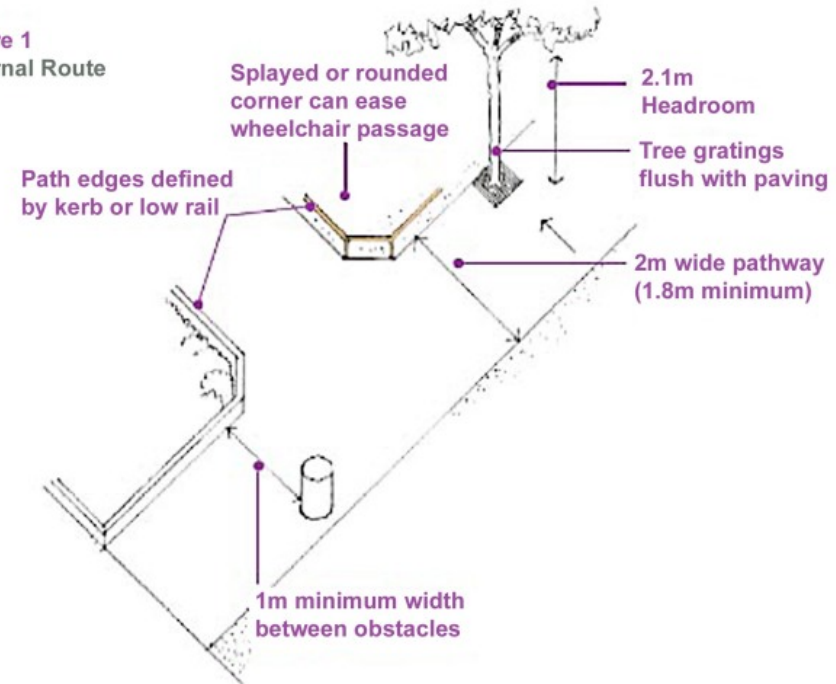

- Not feature drainage gratings or gully covers, unless unavoidable. (If essential, drainage gratings should be positioned as far as possible from the main pedestrian flow, set flush with the surrounding surface, with slots no more than 13mm wide and set at right angles to dominant line of travel);
- Ensure Gaps in paving do not exceed 10 mm;
- Have any street furniture positioned to maintain a 'clear corridor' and allow unhindered pedestrian flow. Street furniture should be clearly distinguishable from its background;
- Not permit the display of freestanding advertising boards;
- Avoid the use of bollards. Where essential, bollards should be at least 1000 mm high, feature a contrasting band and not be chain-linked;

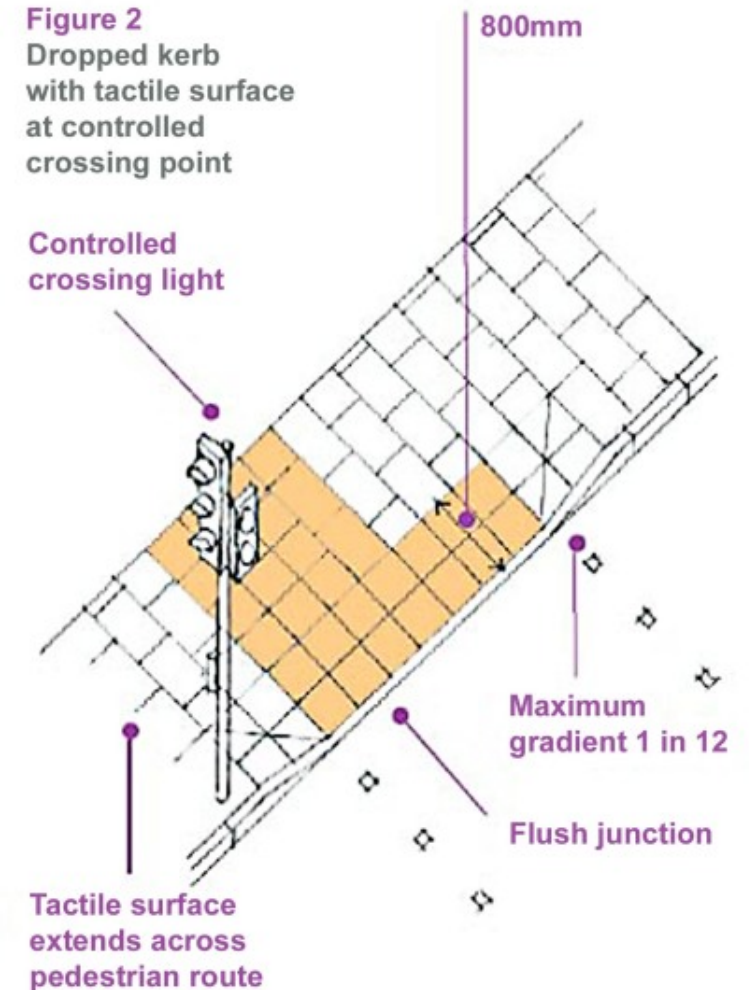

Pavements, footways and other pedestrian routes must also:



- feature dropped kerbs at junctions and designated crossing points with appropriate tactile paving. (All tactile paving must be used sparingly and follow the guidance given in Guidance on the use of Tactile Paving Surfaces, DETR 1998)
- ensure that dropped kerbs are flush with the carriageway, however, a 6mm max. level difference is acceptable using rounded bull nose, if engineering constraints prevent otherwise;

- where waiting is likely, provide seating with armrests and a seat height of 450-500 mm, with space for wheelchairs and pushchairs alongside;
- otherwise conform to the latest BS 8300.



Approach to a Buildings and Facilities

The location and orientation of a building within a site influences accessibility generally, but particularly the distances people need to travel. Careful design minimises access barriers associated with, for example, gradients, walking distances, as well as potential conflicts with cyclists and motorists.

As far as possible, access to a building must:

- be level from the site entrance and throughout;
- be clearly defined and well lit;
- where, due to site constraints, a change of level is unavoidable, ensure a gentle gradient no steeper than 1 in 60 across the whole site, or 1 in 20 with level landings for every 500 mm rise;
- ensure any necessary crossfall is no steeper than 1 in 50;
- only be via a ramp where an Access Statement demonstrates what technical or other constraints prevent an approach gradient of 1 in 20 or less. (Ramp design should follow guidance in this document).

N.B. Where site constraints prevent the installation of a ramp to an existing entrance, it is often possible to adjust the ground level to eliminate steps.



Ramps

Any necessary ramps should be accompanied by steps that serve a principal entrance.

Ramps must:

- be substituted by an alternative means of access, such as a lift, if the total rise exceeds 2m. (Stepped ramps are not permissible);
- ensure ramp length, gradient, and specification adhere to the requirements overleaf;
- have the lowest practicable gradient, preferably not exceeding 1 in 15;
- have a minimum surface width of 1.5m;
- Feature a 100 mm minimum upstand on outer edge(s);
- provide landings at the foot and head of a ramp, at least the width of the ramp and 1.5m minimum length clear of any door swings or other obstruction;
- feature intermediate landings 1.5m long that are clear of any door swings or other obstruction, or potential obstruction;
- Provide a slip-resistant surface;
- provide additional artificial lighting at the top and bottom of flights: at least 200 lux (refer to BS 8300 for detailed guidance);
- NOT feature corduroy tactile warning at the top and bottom of flights.



1. Ramp gradient between landings 10m for 1:20, 5m for 1:15 and 2m for 1:12
2. Width of ramp surface minimum 1200mm
3. Top and bottom landing length 1200mm minimum
4. Intermediate landing length 1500mm minimum
5. Height of kerb to open side of ramp 100mm minimum
6. Nosing to each tread and riser to be contrasting in colour and luminance, 55mm wide
7. Step risers between 150mm - 170mm going between 250mm - 300mm with preference for 300mm
8. Open risers or tapering treads not recommended
9. Return handrail to wall or provide positive end. Handrail 900 - 1000mm above nosing line
10. Extend handrail horizontally beyond top and bottom step 300mm minimum and terminate in a way that reduces risk of clothing being caught
11. Corduroy tactile paving top and bottom or stairs
12. 1200mm space clear of door swing

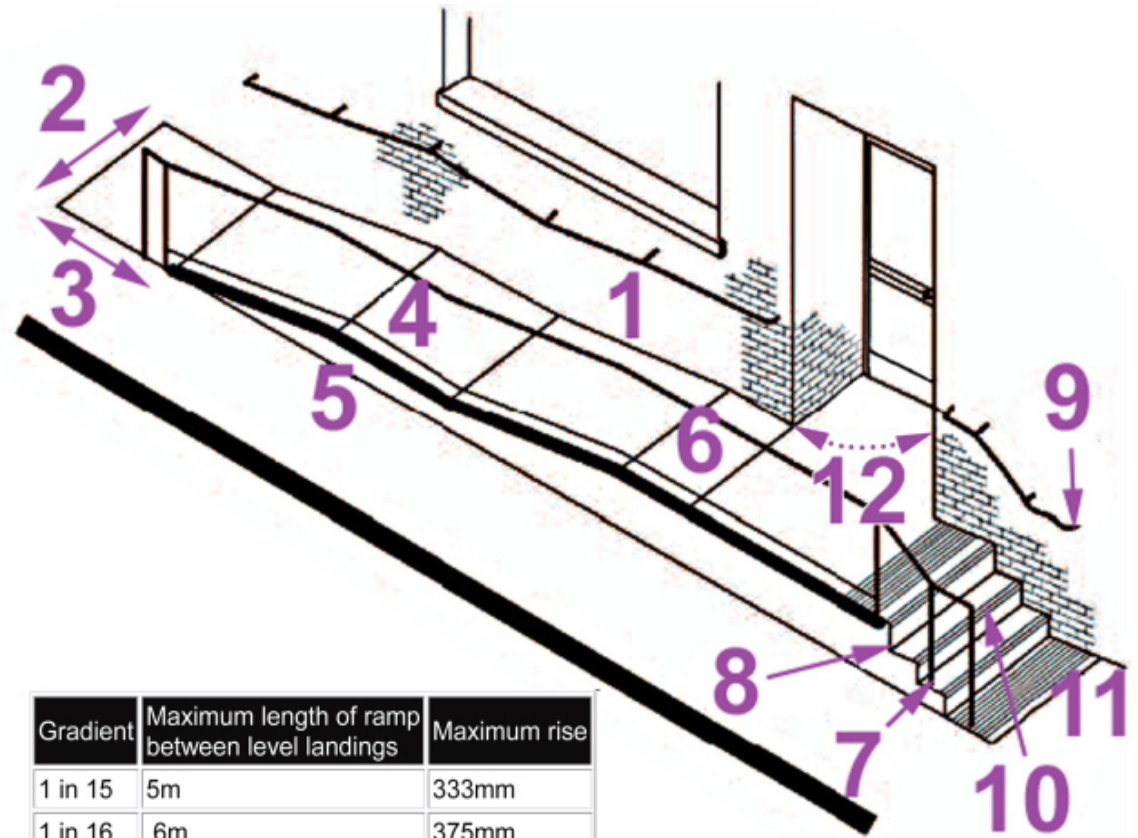

Gradient	Maximum length of ramp between level landings	Maximum rise
1 in 15	5m	333mm
1 in 16	6m	375mm
1 in 17	7m	411mm
1 in 18	8m	444mm
1 in 19	9m	473mm
1 in 20	10m	500mm

Steps

Steps should:



- be 1.2m wide;
- however short a flight, provide continuous handrails on both sides that extend 300mm beyond the top and bottom of a flight;
- ensure handrails are no more than 1800 mm apart; 40 mm - 45 mm in diameter, if circular, and 50 mm if oval; and not cold to the touch;
- ensure a handrail height between 900 mm and 1000 mm from the pitch line, and between 900 mm and 1100 mm from a landing;

- have handrails that end with a 90° turn to the ground or an adjacent wall;
- be slip resistant even when wet;
- be well lit (200 lux minimum);
- provide corduroy tactile warning surfaces at the top and bottom of flights;
- ensure risers measure the same throughout a flight or series of flights;
- provide a level landing at the top and bottom of each flight, not less than 1200 mm²;
- ensure no more than 12 risers between landings;
- incorporate tread nosings that are flush, 55 mm wide, made from a permanent material that contrasts in colour and luminance with the standing and facing surfaces of all risers;
- ensure tread nosings do not project more than 25 mm, where they cannot be avoided;
- otherwise comply with Part M to the Building Regulations, and, Guidance on the use of Tactile Paving Surfaces, DETR 1998.

N.B. Stainless steel handrails must be avoided. They often become too cold to maintain a grip, exacerbate symptoms of arthritis for example, are slippery, particularly when wet, and do not contrast well against glass and other indistinct backgrounds. Alternatives include wood and coated steel handrails.

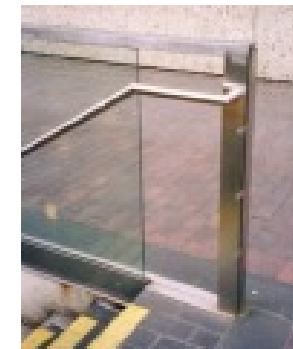

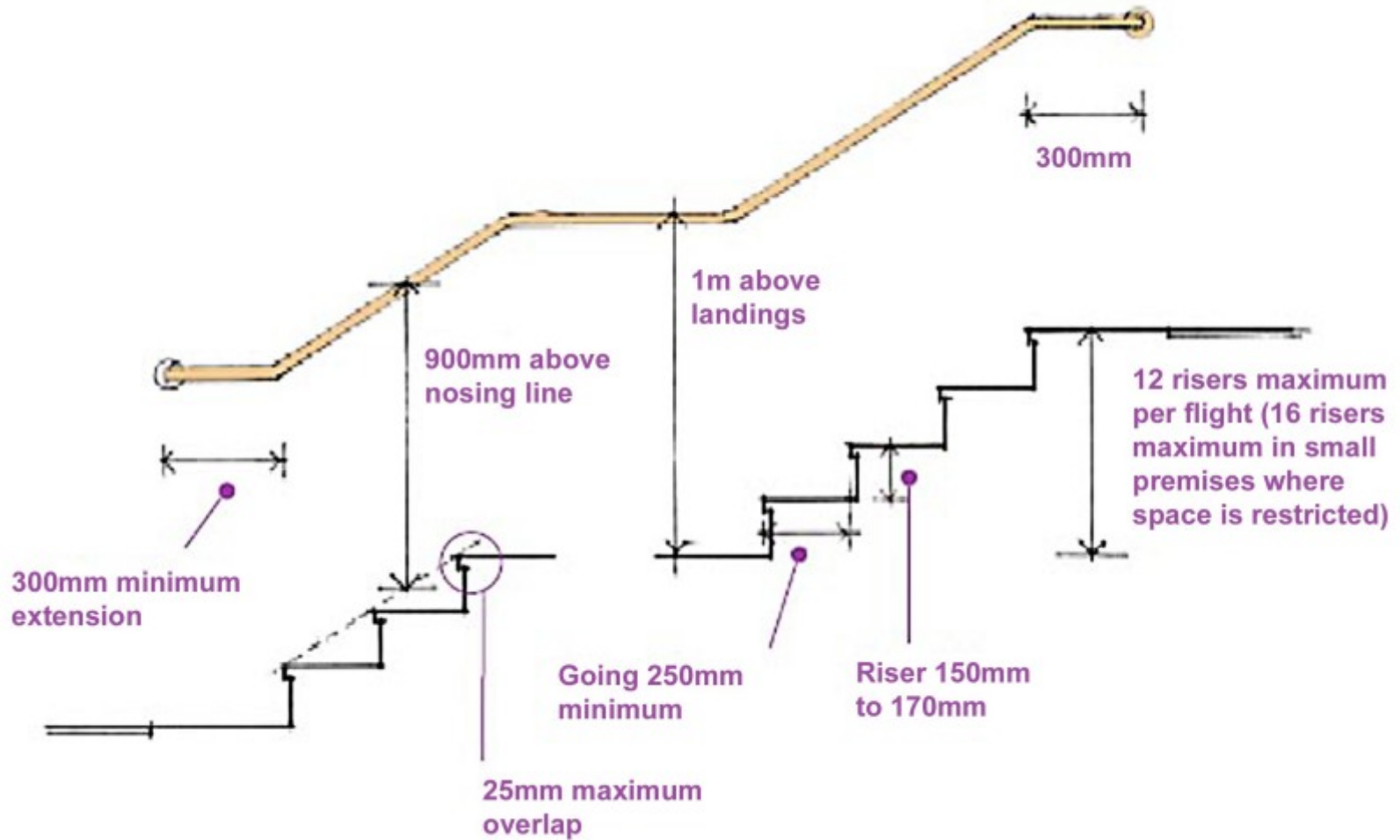

N.B. Consideration should be given to a second lower handrail, at 600mm above the pitch line, for use by people of short stature.

Parking

For many older and disabled people, the car remains an essential and irreplaceable means of mobility.

When designing new developments, or making alterations to existing buildings, planning applicants must consider accessible parking for Blue Badge holders wherever parking spaces are proposed.

Planning applicants must therefore:

- demonstrate where and how many accessible parking spaces will be provided;
- identify within an Access Statement where Blue Badge holders might park and easily access the development, if no off-street parking is proposed;
- provide a setting down point close to the entrance for door-to-door transport vehicles, as appropriate (under cover seating should be considered at picking up points);

Table 3
minimum recommended numbers of bays for Blue Badge holders in off-street car parks

Car park use	Car park size	
	Up to 200 bays	Over 200 bays
Employees and visitors to business premises	Individual bays for each disabled employee, plus 2 bays or 5% of the total capacity, whichever is greater.	6 bays plus 2% of total capacity
Shopping, recreation and leisure, e.g. hotels	3 bays or 6% of capacity, whichever is greater	4 bays plus 4% of total capacity

(source: Traffic Advisory Leaflet 5/95, Department for Transport)

Accessible Parking Spaces for Blue Badge holders

In all off-street non-residential car parks, spaces for Blue Badge holders should:

- be provided as close as possible, but within 50m of the facilities to which they serve;
- in multi-storey car parks, be on a level(s) or close to a wheelchair accessible lift to minimise the amount of walking to the facilities;
- be monitored for abuse and display penalty warning notices for non-Blue Badge;
- measure 2400 mm x 4800 mm, with a shared 1200 mm shared transfer zone;
- be clearly marked with the international wheelchair symbol on the ground and on a signpost at eye level, and otherwise designed and marked in accordance with BS 8300;
- be visible or signposted from the car park entrance;
- be located to allow access to a ticket machine with easy-to-use controls, slots and dispensers (further details are given in BS 8300);
- be close to level and clearly identifiable pedestrian routes.

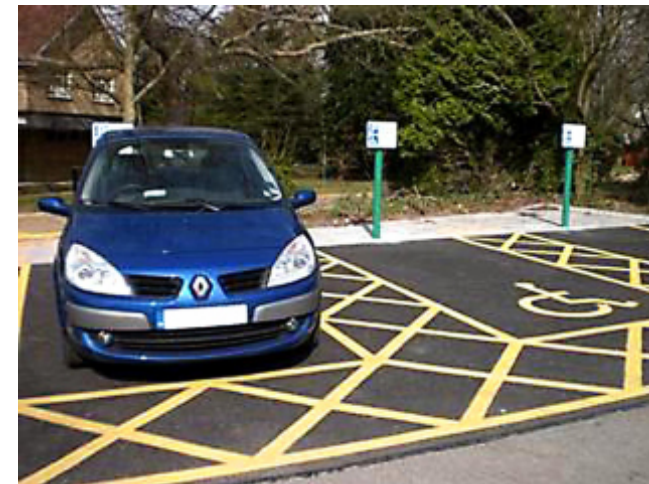

N.B. To make the route more manageable by disabled people, if accessible bay(s) cannot be near to facilities served by the car park, a covered pedestrian walkway, seating along route and good signage should be provided.

Figure 5
Accessible off street
parking bays

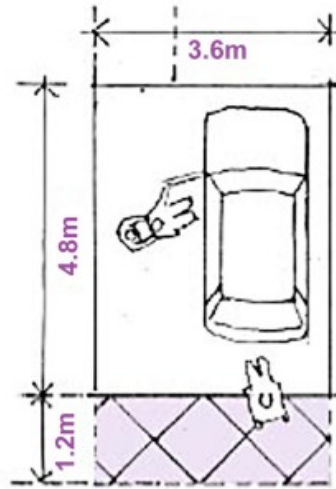

single off street space

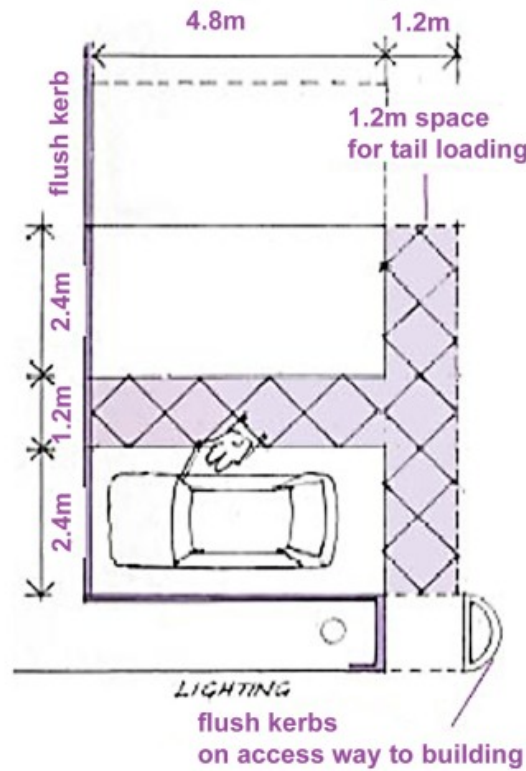

spaces within range
of general parking

figure 06
On street
parking bay

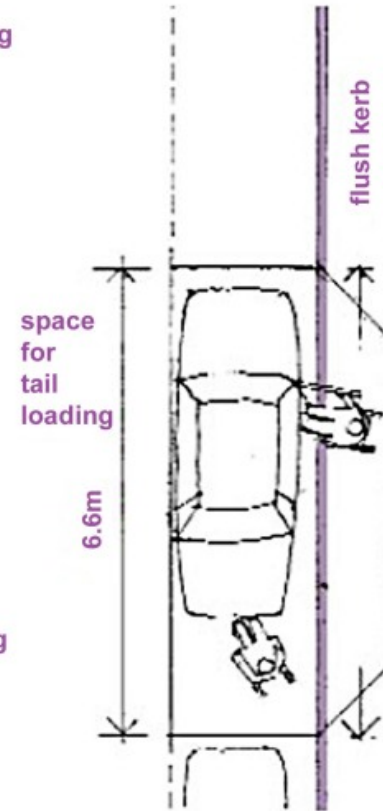

DRAFT

Building Features

Entrances

Entrances into new buildings should:

- be easy to identify without excessive signage;
- be integral to an approach route that is level at all entrances and exits,
- be unobstructed and well lit;
- ensure glazed entrances and screens are marked for safety and visibility at 900 mm and 1500 mm above the finished floor level. The manifestation size (dots, company logo's etc) should be 125 mm wide;
- provide a level threshold (maximum upstand 10 mm, chamfered or rounded);
- ensure the height of any door entry system is suitable for wheelchair users, and has a camera to facilitate access by people with hearing or speech impairments.



Entrance doors

Doors leading into and out of buildings should be easy to open by people with limited manual dexterity or strength, those with a pram or pushchair and wheelchair accessible. To ensure a good standard of access:

- automatic sliding doors should be used in preference to other types of opening. To minimise heat loss, two sets of automatic doors within a drum should be considered.
- if automatic swing doors are essential, the swing area should be protected by guarding to require a head-on approach and minimise the risk of personal injury;
- revolving doors are not considered accessible and their use should be avoided. If used, an adjacent pass door should be provided and kept unlocked during opening hours.
- manually operated doors should require an opening force no greater than 25 Newtons at the leading edge.
- door handles should be easy to grip and in contrasting colour to the door.
- swing doors should have an unobstructed space of at least 300 mm adjacent to the latch side of a door (leading edge).

NB: Stainless steel doors and handles provide poor contrast against glass and should be avoided.

Figure 7
Effective clear width of door opening

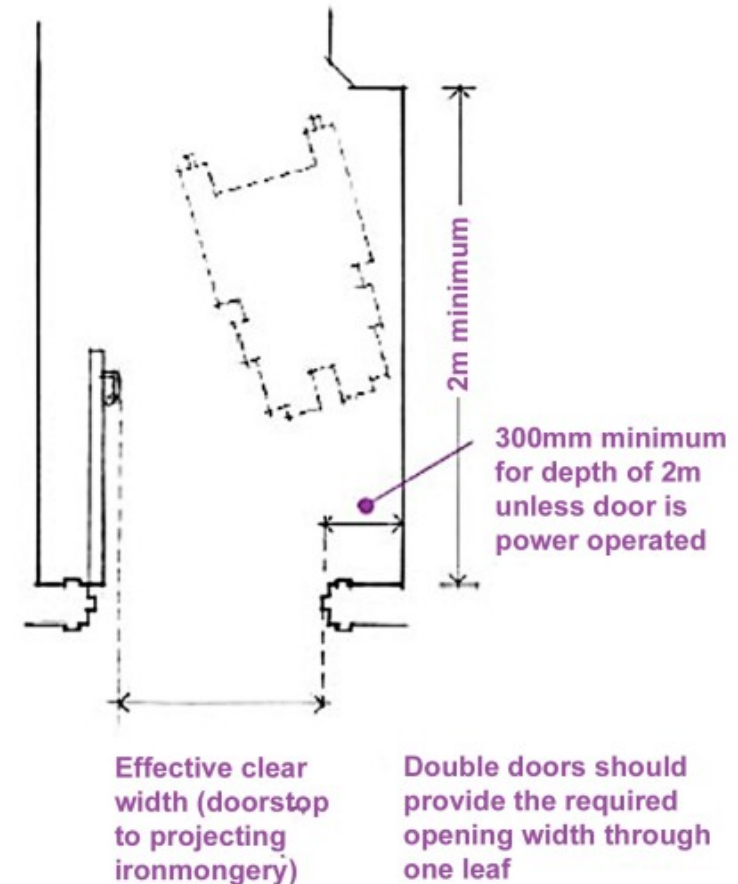

Lobbies

Lobbies should be sized to allow wheelchair users to move clear of one door before negotiating the second. The minimum length of a lobby is related to the door size and swing direction.

Further detail is given in Approved Document M of the Building Regulations, however, as a general rule 1570 mm of clear space should be provided between door swing areas.

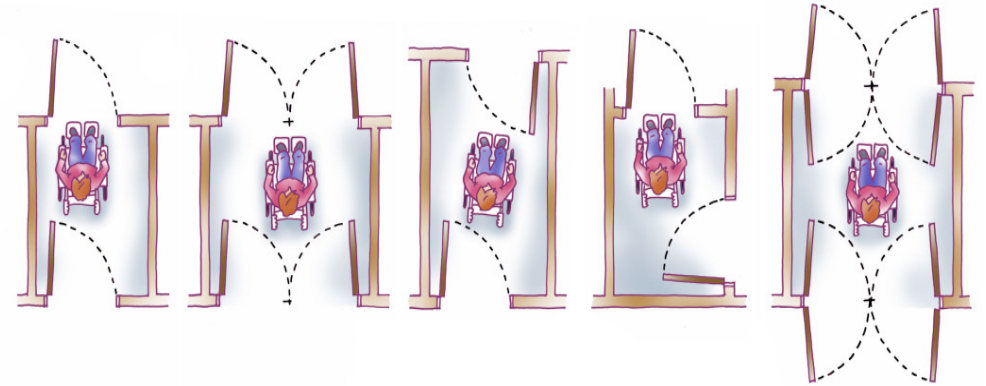

Minimum 1570 mm clear space between door swings

Reception Areas

Reception areas and entrance halls should be easily accessible and convenient to use, and should ensure:

- counters and reception desks allow wheelchair access to the visitor and staff side, and are designed make communication easy for those lip reading, using sign language or hearing aids;
- an induction loop is provided at all reception desks;

Routes from the reception area to stairs, lifts and WCs are clearly defined, unobstructed, and well signed.



Internal Doors

Internal doors in new buildings should have a minimum clear opening width of 800 mm in accordance with BS 8300.

Doors should:

- where fitted with self-closing devices should accord with BS 8300 (see page 14);
- have an unobstructed space of at least 300mm adjacent to the leading edge of the door on the pull side;
- be held open along circulation routes on electro-magnetic devices linked to the fire alarm system;
- feature a vision panel between 900mm to 1500 mm from the floor level along circulation routes and preferably elsewhere (except where privacy is required).

Corridors

Corridors should have an unobstructed width of 1800 mm. Where the width is less than 1800 mm, passing places should be provided at reasonable intervals. See Fig. 8.

Figure 8
Corridors

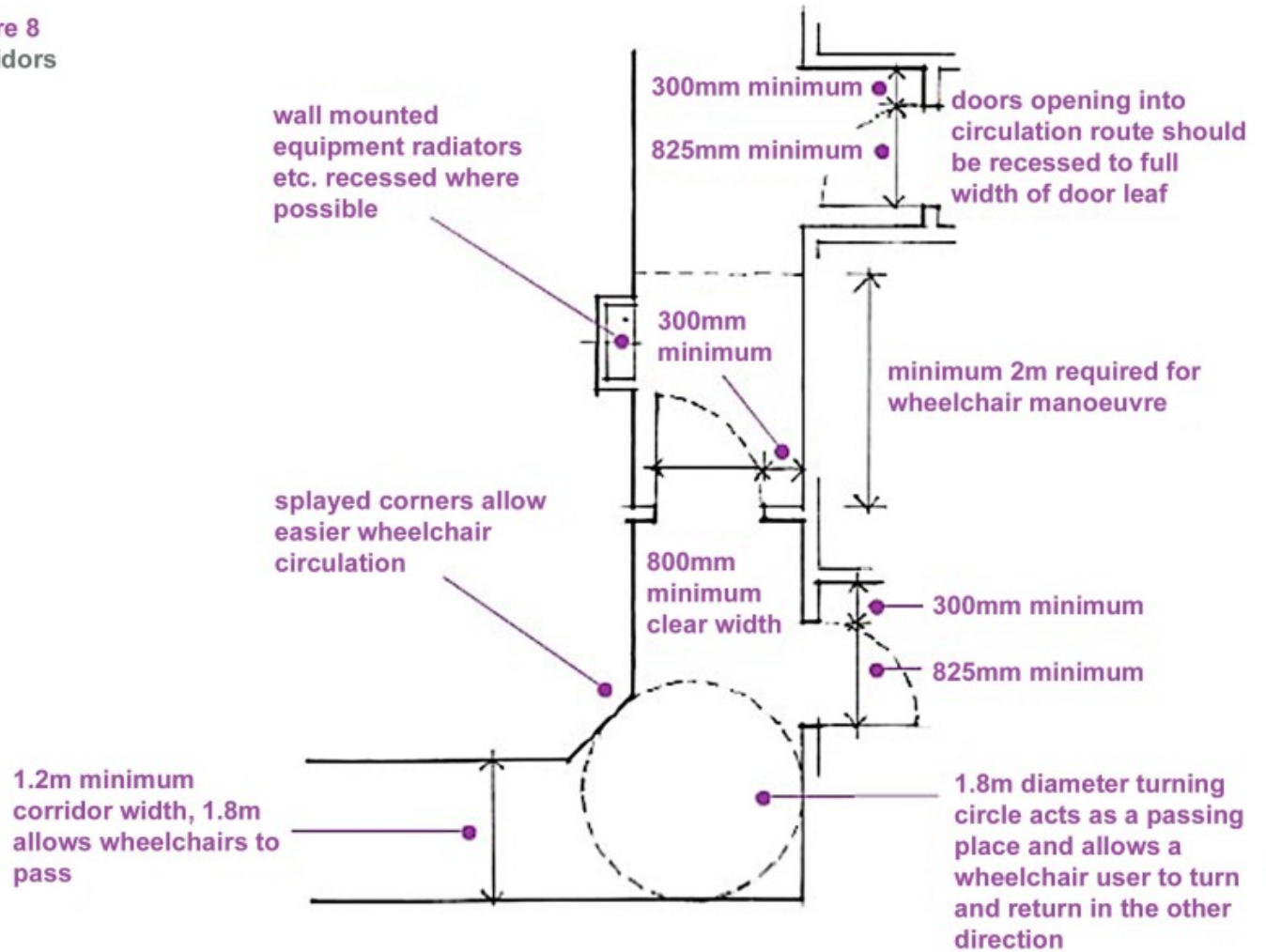

Vertical Circulation

Lifts

A passenger lift should be provided in all new multi-storey developments. See page 51.

In existing buildings, a platform lift (enclosed where lift travel exceeds 2000 mm) may be acceptable.

Platform lifts

Platform lifts are an acceptable solution only in existing buildings and environments. They should be designed to allow independent use with clearly visible controls set at a height suitable for wheelchair users. Ideally they should be located adjacent to the stair with which they are associated.

Platform lifts are operated by continuous pressure controls and travel slowly. They are restricted to a maximum travel distance of 2m where there is no lift enclosure and no floor penetration.

Where travel distance exceeds 2m there should be a lift enclosure. The platform size should be sufficient to accommodate large wheelchairs.

NB: Although wheelchair stair lifts may provide an acceptable solution in some existing buildings, they must not be used in new buildings.

Wheelchair stair lifts should not be used in external environments or as the sole means of access into a building.



Passenger lifts

The size and number of lifts should cater for the anticipated number of people likely to use a building.

Lifts should provide:

- minimum internal dimensions of 1.1m wide by 1.4m deep;
- Increased internal dimensions of 2 m by 1.4 m where frequent use or a high volume of people is anticipated;
- a minimum clear opening door width of 800 mm;
- have an area of at least 1500 x 1500 mm in front of the door on every landing, including ground floor level;
- clearly distinguishable controls with tactile information, between 900mm and 1100 mm above floor level;
- All specification in accordance with Approved Document M of the Building Regulations.

Figure 9
Passenger lift
dimensions

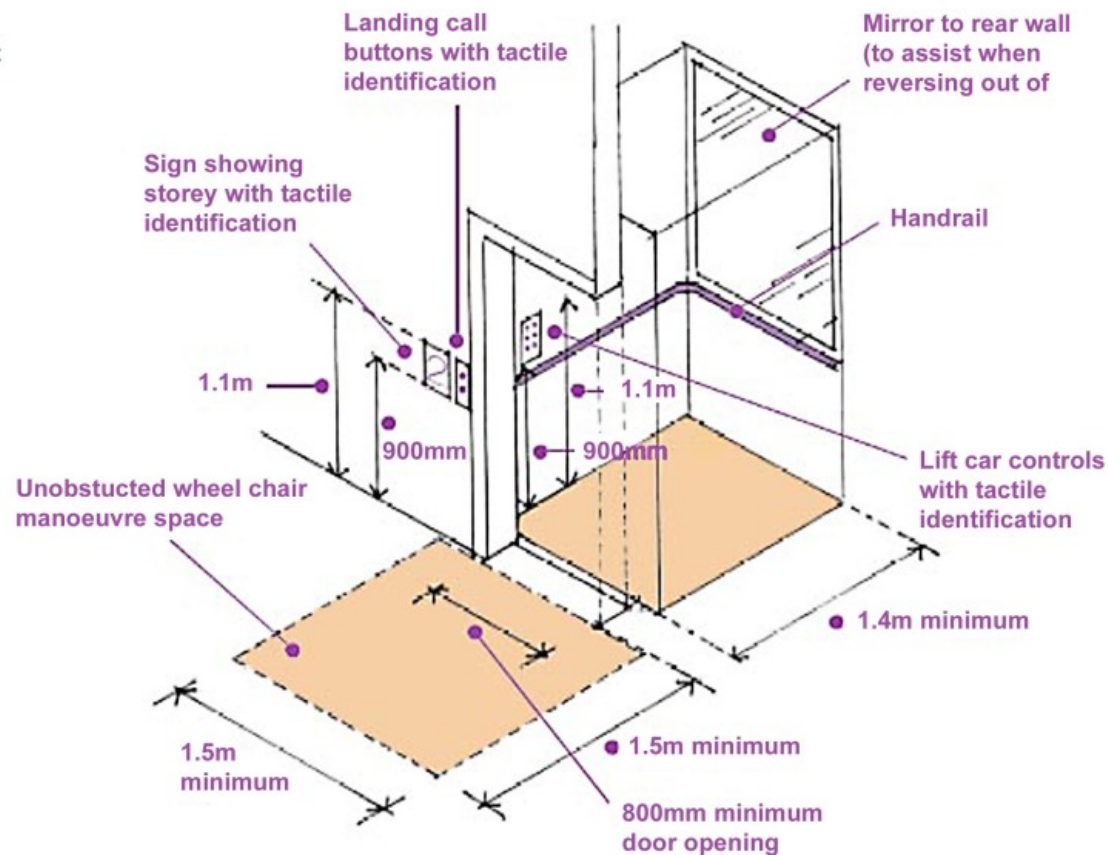

Internal stairs

Stairs should have:

- a minimum surface width of 1.2m;
- a level landing at the top and bottom of each flight across the width of the stair and at least 1200 mm long;
- no more than 12 risers between landings, but exceptionally no more than 16 risers in small premises where the floor area is restricted;
- risers that are not open, between 150mm and 170mm in height with a going of at least 250mm, and the same dimensions throughout a flight or series of flights;

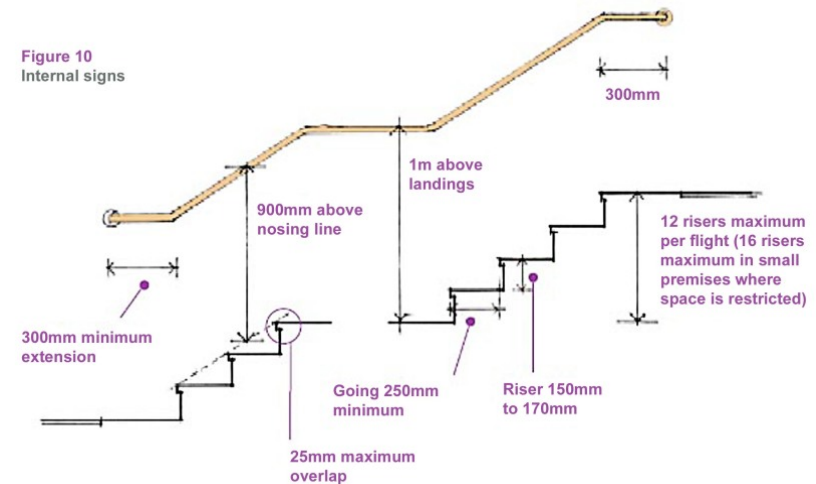

- a handrail height between 900 mm and 1000 mm from the pitch line, and between 900 mm and 1100 mm from a landing;
- handrails that end with a 90° turn to the ground or an adjacent wall;
- incorporate tread nosings that are flush, 55 mm wide, made from a permanent material that contrasts in colour and luminance with the standing and facing surfaces of all risers;

N.B. internal stairs should comply with Part M to the Building Regulations. See also page 40 on steps.

WCs and changing facilities

Toilet facilities should be easy and convenient to use by everyone. WC facilities should:

- be accessible to wheelchair users in accordance with BS 8300 and signed 'Unisex Accessible';
- not feature baby changing facilities within accessible cubicles (baby changing facilities should be provided elsewhere and not in areas kept for disabled people);
- make provision for at least one wheelchair accessible toilet in a building for use by customers, visitors and staff;
- where one toilet is provided in a building be wheelchair accessible;
- ensure minimum internal dimensions of 2200 mm x 1500 mm and otherwise designed and fitted in accordance with BS8300;
- where more than one unisex compartment is proposed, layouts should allow right and left-hand transfer from a wheelchair;
- in separate sex toilet blocks, feature a larger cubicle for ambulant disabled people in accordance with BS8300.

Additional good practice guidance:

- Automatic sliding or bi-fold doors may be considered where space is limited.
- The flushing mechanism should be positioned on the open or transfer side of the WC pan.
- Coat hooks should be fitted at 1200mm and 1800mm above floor level on back of door.
- There should be good use of colour contrast, e.g. fittings, with wall tiles and floor surfaces.
- Basin taps must be located on the side of the basin nearest to the WC and ideally should be a mixer tap with a lever handle.
- It should be possible to reach the basin, tap (s), toilet paper, paper towels whilst sitting on the WC



Figure 11
Unisex accessible toilet
with corner WC

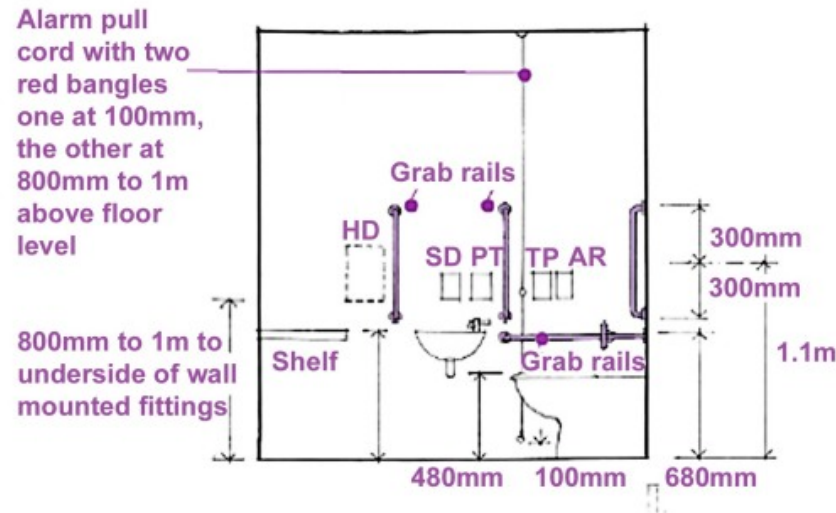

Elevation

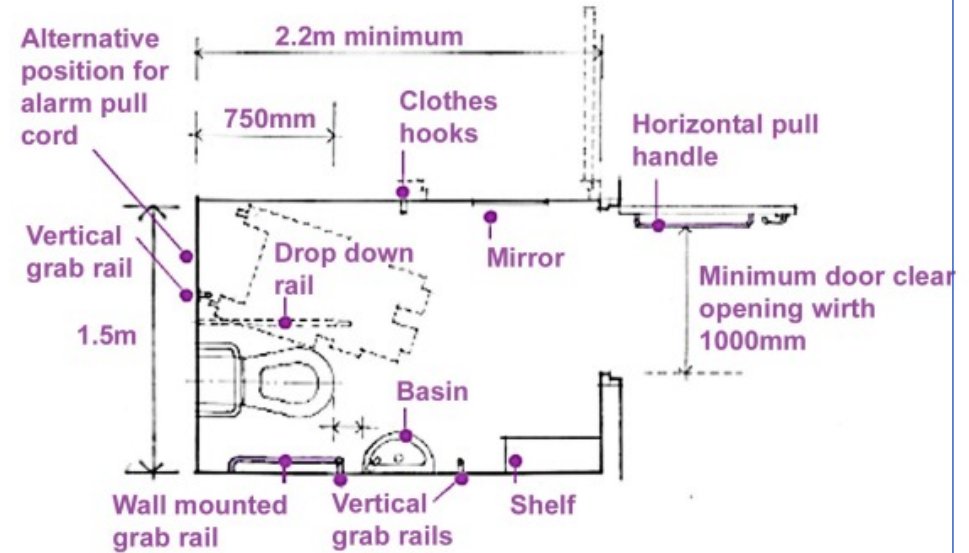

Plan

NB Layout for left hand transfer to WC

- HD: Possible position for automatic hand dryer
- SD: Soap dispenser
- PT: Paper towel dispenser
- AR: Alarm reset button
- TP: Toilet paper dispenser

N.B. Accessible WCs should not feature a baby changing facility. The compartment should be kept free for use by disabled people with separate baby changing facilities provided in a location that is accessible to male and female carers.

Travel distance

A wheelchair accessible WC should be no more than 40 m away at any given point in a building. Where a platform lift is used vertical travel to toilet accommodation is limited to one storey.

Changing Facilities

Changing facilities provided for use by customers or visitors, or by people working in a building, should be designed to be accessible. It is optional to provide a separate self-contained wheelchair accessible changing room or one that provides full access within a general facility.

Changing Places Toilets

Standard accessible toilets do not meet the needs of all disabled people. Changing Places toilets provide extra features and more space to meet particular needs.

In line with BS 8300 : 2009 and the Department for Communities and Local Government (DCLG) strategic guidance 'Improving Public Access to Better Quality Toilets', the Council may require a Changing Places facility in key developments, including:

- major transport termini or interchanges, e.g. large railway stations, airports and motorway services;
- sport and leisure facilities, including large hotels;
- cultural centres, such as museums, concert halls and art galleries, stadia and large auditoria;
- shopping centres and shopmobility centres;
- key buildings within town centres, e.g. main public libraries;
- educational establishments;
- health facilities, such as hospitals, health centres and community practices.

Each Changing Places toilet must provide:

- a height adjustable adult-sized changing bench;
- a tracking hoist system (or mobile hoist if this is not possible);
- adequate space in the changing area for the disabled person and up to two assistants;
- a centrally placed toilet with room either side for the assistant(s);
- a screen or curtain to allow the disabled person and assistant(s) some privacy;
- a wide tear off paper roll to cover the bench;
- a large waste bin for disposable items;
- a non-slip floor.

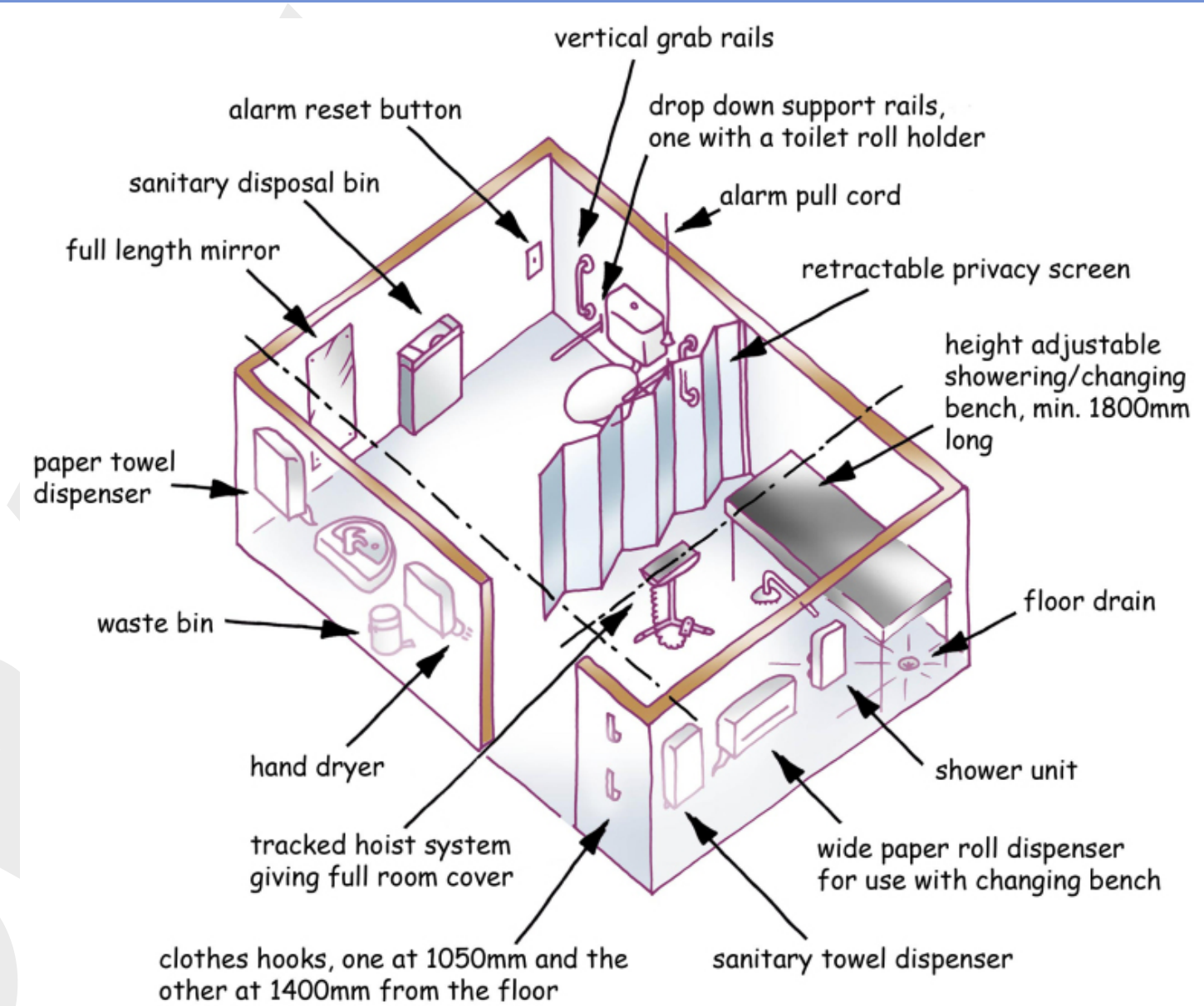

Changing Places Toilet

Communication and Wayfinding

Building design should provide a logical and straight forward layout that enables people to move around a building intuitively, without the need for excessive signs. Good use of lighting, colour and tonal contrasting, clear and appropriate signage, hearing enhancement systems and acoustic environments need careful consideration when designing buildings.

Signage

If a building is designed in a rational and simple manner the need for signs is minimised. However, where signs are used they should be well placed, well lit and use clear visible print. The use of symbols and tactile information will benefit many building users.

For further information see the Sign Design Guide, a guide to inclusive signage, JMU Access Partnership and the Sign Design Society, 2004.



DRAFT

Lighting

Good lighting is essential for visibility and strong definition of objects. It allows people to identify potential hazards such as changes of levels more easily. Light sources should be positioned to avoid glare, reflection and strong shadows to aid sign language and lip reading.

Other points to consider:

- a lighting strategy should take account of all building users including disabled people;
- buildings should be designed to make maximum use of natural lighting;
- lighting should avoid creating glare and reflections, pools of bright light and stark shadows as these can mask hazards;
- surfaces should have a non-reflective finish e.g. table tops, handrails;
- lighting should be difused, carefully positioned and not in the line of vision.

Hearing Enhancement Systems

Hearing enhancement systems are used to amplify sounds and eliminate extraneous background noise in rooms and areas for meetings, lectures, performances, film and spectator stadia, as well as service counters.

Induction loops or infrared systems enable a person to receive crisp sound direct to their hearing aid.

Infrared systems are virtually immune from florescent lighting and air conditioning interference and are undoubtedly the preferred option for confidential conversations.

N.B. For further technical advice or guidance contact the Royal National Institute for the Deaf.

Entry Phones

Entry phones should be designed and located to be used by wheelchair users with hearing and visual impairments.

They should:

- feature a camera and video screen to facilitate two-way visual dialogues;
- be no higher than 1200 mm from the floor.

Telephones

Where public telephones are provided in a building, at least one should be accessible to wheelchair users. Where there is a selection of telephones with different payment methods one of each type should be accessible.

Alarms

Alarm systems should take into account the needs of people with hearing impairments through flashing beacons and/or, in large or complex environments, linked to a dedicated paging system.

Facilities

Storage Facilities

Storage cupboards, shelves and lockers should be designed to allow their easy use by disabled people, including wheelchair users. Consideration should be given to height and keeping the need for fine manual dexterity to a minimum

Refreshment Areas

Restaurants and cafeterias should be accessible with split-level areas linked by ramps, adequate circulation space, a choice of wheelchair seating locations and accessible self-service facilities.

Counters and Service Desks

Counters and service desks should be accessible to customers and staff using wheelchairs.

Controls and Equipment

All controls, switches, and sockets should be easy to operate, and at a consistent height and location throughout a building.

Card and coin operated devices (such as automatic teller machines (ATMs) and vending machines) should be designed and located to allow easy, independent use. They should:

- positioned so that display screens can be seen from a wheelchair height;
- feature buttons that are well spaced, colour contrasted and tactile characters;
- be no higher than 1300 mm (preferably 1200 mm);
- a clear level area of 2000 mm x 2000 mm in front of a machine.

Means of Escape

Safe, efficient egress depends upon a combination of building design and management procedures. A well-designed, accessible building should allow independent egress for all building users and should:

- feature (in multi-storey buildings) at least one fire rated evacuation lift within a refuge area. The lift(s) should be designed and integrated to support Horizontal Evacuation and:
 - i. must be clearly identifiable and have appropriate signage.
 - ii. should be situated within a protected enclosure.
 - iii. should consist of lift well and protected lobby at every level.
 - iv. should be provided with a switch marked "Evacuation Lift" at Exit level. (This switch should cause the lift to return to the final exit & then become controllable.) Alternatively, the lift could be interfaced to the fire alarm system, returning to ground when the alarm sounds.
 - v. must feature an exclusive primary electricity supply from a sub-main circuit.
 - vi. must have an alternative back-up power that should start automatically in an emergency to prevent potential interruption to the electricity supply. The cables should be separate from those of the primary supply and routed through an area of low fire risk.
 - vii. must have power switches or isolators that are clearly identifiable and labeled at the main switchboard and alternative power supply to indicate the location of the other supply.
 - viii. must connect to any electrical sub-station, distribution board, generator, hydraulic pump or other apparatus that is fire protected for a period not less than that of the lift shaft.
 - ix. have a minimum load capacity of not less than 400kg.
 - x. should have doors that have a minimum of 2 hours fire resistance.

- ensure a minimum sized refuge of 900 mm x 1400 mm on every floor (refuges should be clearly sign posted and their purpose made known);
- provide an Emergency Voice Communication System (EVC), in compliance with BS5539-9 2003 in all refuge areas and in various locations throughout a building;
- provide a video surveillance for all refuge areas;
- ensure emergency lighting (minimum 3 lux) is provided along escape routes;
- ensure exit doors provide a level threshold and open on to a suitable level area;
- refer to BS9999, and approved Document B of the Building Regulations.

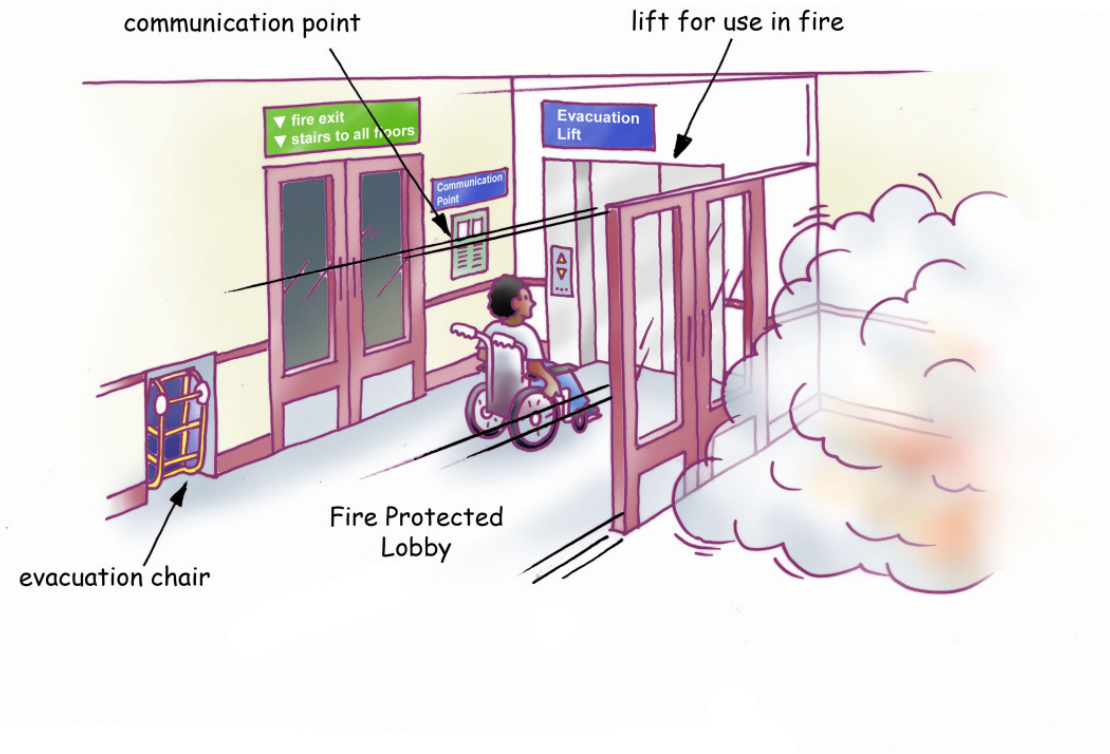

NB: manual methods of evacuation (e.g. EVAC chairs) should be avoided. They are slow, typically cumbersome, and rely on a non-disabled person prolonging their stay in a building that is potentially dangerous.

12 Specific Building Types

A1 Retail (includes Supermarkets)

Counters and Checkouts

- Counters should be accessible to wheelchair users as staff and customers.
- Shop checkouts should allow wheelchair access and at least one in every shop should be 900mm wide.
- The maximum height of counters, desks and shop checkouts should, at least in part, be a maximum of 800mm to allow easy use by people in wheelchairs.
- Till displays should be positioned at a height suitable for wheelchair users and the installation of induction loops may also be appropriate.

Aisles and Shelves

- There should be sufficient space between display shelves for a wheelchair user to turn. Aisles should have a minimum width of 850mm, or 1.2m in supermarkets.
- Wherever practicable shelving should be positioned where disabled people can reach it independently. The most accessible shelf heights to reach from a seated position are between 630mm and 1.17m above floor level. A maximum shelf depth of 220mm is recommended.
- In retail stores with changing facilities, at least one changing room should be designed to be suitable for an ambulant disabled person or a wheelchair user plus companion and have a minimum floor area of 1.5m x 1.5m.

Shop Fronts

- New shop fronts should be accessible to disabled people. Changes of level at entrances should be avoided, but where unavoidable a ramp should be provided in accordance with the guidance in this document. In the case of existing buildings, particularly where a new shop front is proposed, the following guidance should be followed:
- Shops that have a change in level of under 180mm from pavement to shop floor surface can usually incorporate ramped access into or within the shop. (Exceptions preventing a ramped area to be created may include the presence of structural beams, floor slabs, socket outlets or basement lights.)
- Entrance doors should be accessible to all, particularly wheelchair users and people with limited manual dexterity. 1000mm minimum effective clear width in new buildings and 800mm width in existing buildings where a new shop front or alterations to a shop front are proposed.

NB: Further detail and design guidance is given in the 'Entrances' section of this document and a in the Hillingdon Design and Accessibility Statement (HDAS) Shopfronts SPD.

A3 Food and Drink

- Restaurants, cafeterias and bars should be designed to be accessible with split-level areas linked by ramps, adequate circulation space, a choice of wheelchair seating locations and accessible self-service facilities.
- Entrances should be designed to allow easy access for wheelchair users and ambulant disabled people, (see guidance on 'Entrances' Page 45 & 46.
- Bars and self-service counters (or sections of them) should be at a level suitable for wheelchair users, preferably 800mm high.
- Fixed seating should be avoided.

N.B. All public areas, including WC accommodation, public telephones and external terraces should be accessible and designed in accordance with guidance in this document.

Sports and Leisure Venues

- Facilities should be provided at sports and leisure venues to allow disabled people to participate in all the available activities as spectators, participants and members of staff.
- Disabled people should have access to the full range of seating options and be able to sit alongside disabled or other companions. Routes should be accessible and handrails always provided to ramps and steps. Where turnstiles are installed, a by-pass gate of 800mm should be provided for wheelchair users and ambulant disabled people.
- Spectator seating should be in line with the guidance given in 'cinemas, theatres and other places of assembly' (see page 66).
- Toilets, bars and other facilities within the building should also be fully accessible. Changing room facilities should be provided in accordance with the guidance given on Pages 53-57.
- Induction loops, infra red systems or other suitable communication devices should be provided where appropriate.
- A hoist or ramp should be provided to facilitate access to swimming pools.

Detailed guidance on the design of sports facilities is given in Access for Disabled People, Sport England 2002 (downloaded from www.sportengland.org).

Cinemas, Theatres And Other Places Of Assembly

All assembly areas should allow access and use by disabled people as members of an audience, participants and members of staff. Disabled people should have access to the full range of seating options and be able to sit alongside disabled or other companions.

To be accessible spectator seating should:

- provide a wheelchair space for every fifty seats provided and, in some areas, two wheelchair spaces side by side;
- provide clear visibility lines for wheelchair users without obstructing the view of others;
- otherwise accord with BS8300.

Box office counters should be accessible for wheelchair users and other disabled people, (see Page ?? for guidance on counters design).

Accessible seating should accord with Document M of Building Regulations.

Hotels, Motels And Student Accommodation

A proportion of the sleeping accommodation in hotels, motels and student accommodation should be designed for use by wheelchair users. At least one wheelchair accessible bedroom should be provided for every 20 bedrooms, and should provide a mixture of bathtub and continental style level access shower (Wet Room) en-suite rooms.

NB:

The requirement for accessible accommodation applies to new build, conversions and refurbishments. Reference should be made to all relevant sections of this document and compliance with BS8300 is also required.

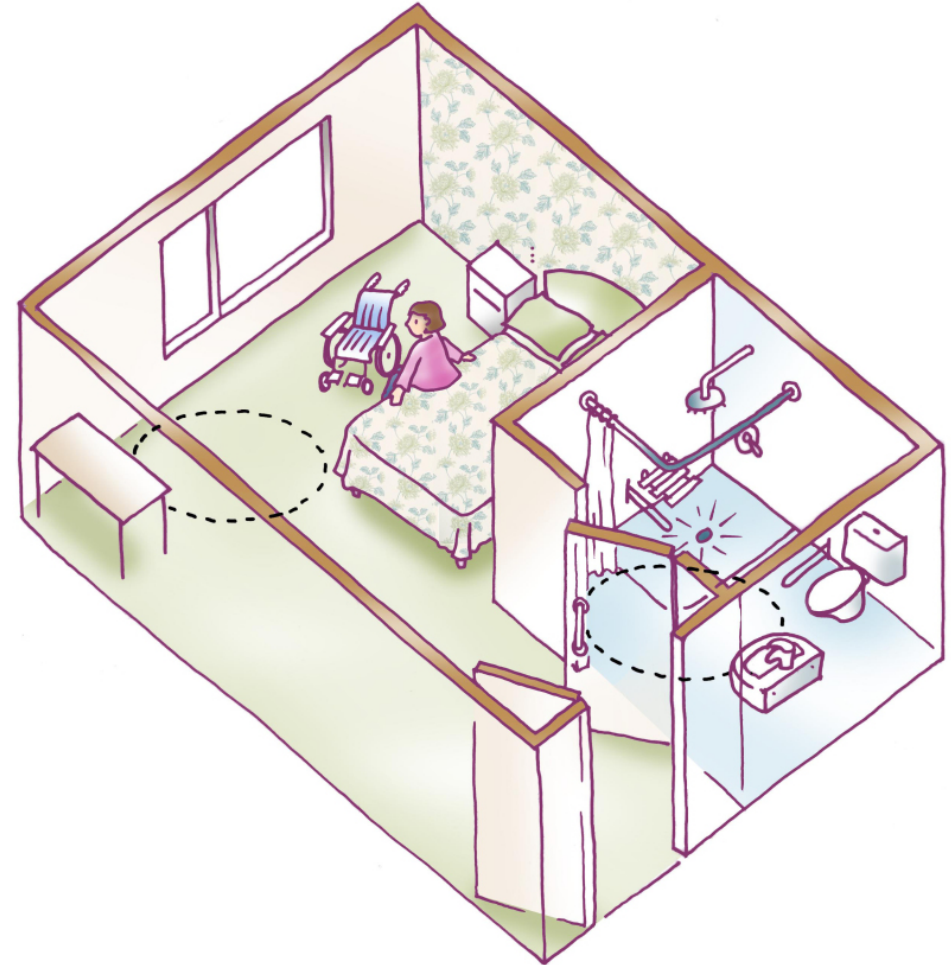

Educational And Cultural Buildings

Education and social interaction is fundamental to the learning and development of everyone. In recent years, disabled people have been empowered to learn and be part of a total education system where the environment is barrier free and discrimination eliminated.

All learning establishments, ranging from nurseries to universities, should follow the guidance of BS 8300 and should:-

- provide a level or gently sloping approach and step free access into all buildings via a common entrance;
- promote barrier-free movement to and around all areas, including all classrooms, lecture theatres, refectory and student accommodation;
- allow students to participate inclusively through assistive technology and built-in flexibility to support those with diverse access needs, e.g. height adjustable work-benches, hearing enhancement systems;
- a building is designed to encourage social interaction of all, including areas such as, refreshments, and quiet study places and recreational opportunities;
- provide soundproof study areas e.g. in the library, to allow people with a visual impairment to work with an assistant reading aloud.

N.B. In accordance with BS 9999, the council will expect all development proposals to include a comprehensive fire emergency plan that demonstrates how disabled people will be safeguarded from fire and enabled to evacuate independently.

DRAFT

Conservation And Historic Buildings

There are particular issues that should be considered when applying the guidance in this document to historic buildings, in Conservation Areas and in Areas of Special Local Character.

In most cases it is possible to reconcile the interests of conservation and achieve suitable access for disabled people without compromising the special architectural interest of a building or area. Where there is a conflict between conservation and access, the Access Statement can be used to explain why a generic solution is impracticable or undesirable, and propose a bespoke solution or means of substituting physical access. The Access Statement should also detail any consultation taken with local access groups, the access and conservation officers or other bodies such as English Heritage.

N.B. See also Planning Policy Guidance Note 15 Planning and the Historic Environment and Easy Access to Historic Properties.

Access to Parks and Open Spaces

Access to parks, open spaces and countryside should ensure:

- physical access for everyone, including wheelchair users;
- appropriate surfaces and gradients are provided;
- adequate seating along extended walking routes;
- facilities such as toilets, picnic tables and observation hides are accessible;
- gates can be used by wheelchair users;
- signs are located to be visible, appropriate (not used excessively), and easily understood;
- information leaflets follow clear print guidelines and are available in alternative formats.

NB:

For further information see 'A Good Practice Guide to Disabled People's Access in the Countryside'; and, 'Easy Access to Historic Landscapes, English Heritage, 2005', visit: www.english-heritage.org.uk/.



13 Access Statements

What an Access Statement should include

For Minor & Major Planning Applications

To include all new dwellings, up to 9 units, including conversions to flats (except householder application). The statement should:

- Explain how the proposal complies with local development policies.
- Explain how issues affecting public access to and within the proposed building or space, such as entrances, horizontal/vertical circulation, WCs and emergency escape, etc, are addressed.
- Demonstrate precisely how the proposal meets Lifetime Home Standards.

For Major Planning Applications

The purpose of the Access Statement is to outline how a project has been designed to deliver an inclusive environment for all to use. The statement should:

- Explain the philosophy and approach to inclusive design, including how the design has come about and what it hopes to achieve.
- List the sources of advice and technical guidance used, as well as pre-planning consultations e.g. with the Council's Access Officer.
- Provide details of any professional advice such as access audits or design appraisals.
- Where the design deviates from recognised sources of good practice, demonstrate why and what alternative features are included to achieve access and inclusion.
- Give details of all management and maintenance practices necessary to ensure the building and/or space remains accessible throughout its lifetime.
- In the case of existing buildings, particularly Listed Buildings and those in Conservation Areas, identify the constraints imposed by the existing structure and to propose compensatory measures where full accessibility proves to be impracticable or unreasonable.

The statement should demonstrate how the following issues have been addressed in an inclusive manner:

1. Approaches to and around the site, including transport links, car parking, setting down points, and the location of dropped kerbs.
2. All entrances, including visibility.
3. General horizontal/vertical circulation and layout arrangements.
4. Appropriate use of surface materials.
5. Facilities within the building, including WC provision.
6. Way-finding and signage.
7. Reliable and independent means of escape for those unable to use stairs.
8. Developers of residential schemes will need to include details of how the development meets Lifetime Home standards and Wheelchair Home standards.

The applicant would also be advised at this stage to consider the implications of the Disability Discrimination Act 1995 (amended 2005) when designing the scheme; to ensure the proposal and its management work within the spirit of the Act and mitigate against any challenges. Useful references include:

1. BS 8300:2009 'Design of buildings and their approaches to meet the needs of disabled people' – Code of Practice' (BSI).
2. Inclusive Mobility – A guide to best practice on Access to Pedestrian and Transport Infrastructure, 2002 (Dept for Transport).
3. BS 9999: 2008 ' Code of practice for fire safety in the design, management and use of buildings'
4. English Heritage – 'Easy Access to Historic Buildings' 2004.
5. Sport England – 'Access for Disabled People' 2002.

Examples of a Design and Access Statement

The content of an Access Statement will depend upon the size, nature and complexity of the proposed development. The following examples illustrate this:

1. Application for an extension to a Restaurant in a Public House

This application is for a small extension to a PH. The proposed extension will include a wheelchair accessible WC as well as additional floorspace for the PH. Current access to the PH is unaffected (it does provide level access) and the proposed wheelchair accessible WC will comply to the standards in Part M of the Building Regulations.

2. Application for an extension to a Restaurant

Proposal: This application is for an extension to the side of a restaurant. The proposal includes a new entrance and the re-location and improvement of the existing sub-standard wheelchair accessible WC.

- The additional new entrance will be step-free. (Currently access can only be gained via a flight of three steps at the front of the restaurant). Access to this entrance will be via a slight slope with an approximate 1:30 gradient. This pathway surface will be slip-resistant.
- The new double entrance doors achieve a total width of 1700mm - as such suitable for wheelchair users. The doors will be fully glazed - as such there will be permanent and visible manifestation to comply with Part M of the Building Regulations.
- The new entrance will be well lit and there will be good directional signage from the front main entrance and from the car-park.
- A new wheelchair accessible WC is proposed - it will comply with Part M of the Building Regulations in terms of size and layout, e.g. 2100mm x 1500mm. Access to it will include a new 1200mm wide corridor.

Sources of Reference:

HDAS: Accessible Hillingdon.

Good Loo Guide, Centre for Accessible Environments.

Council's Information Officer and Access Officer (Planning & Community Services).

3. Application for a new shopfront and internal alterations

Proposal and background: This application is for a new shopfront together with internal alterations to the shop – internally ramping the area around the entrance and the provision of a new lift to the lower ground sales floor.

Currently this large chain store can only be accessed via a large step and narrow doorway. In addition, the existing two sales floors only provide stepped access between each floor.

- The new shopfront will create a level threshold at the entrance and will comply with planning requirements, as well as the Council's 'Accessible Hillingdon' Supplementary Planning Document.
- An automatic sliding door will provide easy entry for everyone.
- The area beyond the entrance level landing will gently slope at a gradient of 1:25 up to the ground floor sales area. The 1:25 gradient does not require handrails as the slope is shallower than 1:20.
- A new 8 person size lift (1.1m x 1.4m) will provide a step-free access route to the lower ground sales floor.

Sources of reference:

Hillingdon Design and Accessibility Statement: Accessible Hillingdon.

Part M of the Building Regulations.

Council Access Officer (Planning & Community Services).

14 National Planning Policy Statements and Guidance

Objective

Planning Policy Statement 1 (PPS1): General Policy and Principles (2005)

PPS 1 Makes reference to development providing an opportunity to secure a more accessible environment for everyone and notes that local planning authorities should take into account access issues, including access to and into buildings and the need for accessible housing. It states that developers and local planning authorities should consider access at an early stage, and be flexible and imaginative in seeking solutions, taking into account the particular circumstances of each case.

Objective

Planning Policy Statement 3 (PPS3): Housing (2006)

PPS3 underpins the delivery of the Government's strategic housing policy objectives and the goal to ensure that everyone has the opportunity to live in a decent accessible home, which they can afford in a community where they want to live.

Objective

Planning Policy Statement 6 (PPS6): Positive planning for Town centres (2005)

PPS 6 includes as a key issue meeting the access and mobility needs of disabled people. It notes that in new retail developments, local authorities should seek to ensure safe, easy access for disabled people. It states traffic and town centre management strategies should meet the needs of disabled people and there should be good access to shops and other facilities.

Objective

Planning Policy Statement 12 (PPS12): Local Spatial Planning (2008)

PPS 12 explains what local spatial planning is and how it benefits communities. It sets out the key ingredients of local spatial plans and key government policies on how they should be prepared. Local planning authorities should take PPS12 into account when preparing development plan and other local documents.

Objective

Planning Policy Guidance Note 13 (PPG13): Transport (2001)

PPG 13 notes that local authorities, developers and transport providers should work together to seek to meet the accessibility needs of disabled people in all developments. It notes that local authorities, in developing and implementing policies on parking should require developers to provide designated parking spaces for disabled people in accordance with current good practice.

In addition, ensuring developments should be adjacent to transport infrastructure, protect or improve step free access to train, bus and underground stations.

DRAFT

Objective

Planning Policy Guidance Note 15 (PPG15): Planning and the Historic Environment (1994)

PPG 15 states that it is important in principle that disabled people should have dignified, easy access to and within historic buildings.

It goes on to say that it should normally be possible to plan suitable access without compromising a building's special interest.

Objective

Planning Policy Guidance Note 17 (PPG17): Planning for Open Space, Sport and Recreation (2002)

PPG 17 states that local authorities should take into account the mobility needs of the local population and should ensure that facilities are accessible for disabled people.

15 Best Practice Sources and References

Access for Disabled People Sport England 2002
(<http://www.sportengland.org>)

The Access Manual by Ann Sawyer and Keith Bright,
Blackwell Publishing 2003
(<http://www.bookshop.blackwell.co.uk>)

Building Bulletin 94: Inclusive school design:
accommodating pupils with Special Educational Needs
and disabilities in mainstream schools DfEE 2001
(<http://www.teachernet.gov.uk>)

Designing for Accessibility – an essential guide for
public buildings - Centre for Accessible Environments
2004 (<http://www.cae.org.uk>)

English Heritage 2005 - Easy Access to Historic
Properties (<http://www.english-heritage.org.uk>)

Guidance on the Use of Tactile Paving Surfaces
DETR 1998 Reprinted 2002 (<http://www.dft.gov.uk>)

Lifetime Home Standards,
(<http://www.lifetimehomes.org.uk>)

Planning and Access for Disabled People: A Good
Practice Guide ODPM, March 2000
(<http://www.communities.gov.uk>)

National Wheelchair Housing Association Group
(NATWHAG) Wheelchair Housing Design Guide
Second edition 2006 (<http://www.habinteg.org.uk>)

Access Statements – achieving an inclusive environment
by ensuring continuity throughout the planning, design
and management of buildings and spaces - Disability
Rights Commission 2004
(<http://www.equalityhumanrights.com>)

Approved Document M (2004 edition) The Building
Regulations 2000 (<http://www.planningportal.gov.uk>)

Building Bulletin 95: Schools for the Future, Designs
for Learning Communities 2002
(<http://www.teachernet.gov.uk>)

Good Loo Design Guide Centre for Accessible
Environments 2004 (<http://www.cae.org.uk>)

English Heritage 1995 2004
(<http://www.english-heritage.org.uk>)

Inclusive Mobility: a guide to best practice on access
to pedestrian and transport infrastructure Mobility and
Inclusion Unit Department for Transport 2002
(<http://www.dft.gov.uk>)

Living Well Together, achieving sustainable, flexible
homes within high density neighbourhoods Habinteg,
GML Architects, Joseph Rowntree Foundation and Greater
London Authority, 2003 Lifetime Homes Standards
Joseph Rowntree Foundation 2000
(<http://www.habinteg.org.uk>)

Scheme Development Standards: The Housing
Corporation, 2003 (<http://www.housingcorp.gov.uk>)

Accessible Thresholds in New Housing: guidance
for house builders and designers DETR 1999
(<http://www.ribabookshops.com>)

British Standard BS 8300: 2009 Code of Practice
for design of buildings and their approaches to
meet the needs of disabled people BSI 2009
(<http://www.bsi-global.com>)

Building Sight: A Handbook of Building and Interior
Design Solutions RNIB 1995
(<http://www.jmuaccess.org.uk>)

Developing Accessible Play Space: A Good Practice
Guide ODPM 2003 (<http://www.communities.gov.uk>)

A Good Practice Guide to Disabled People's
Access in the Countryside BT / Fieldfare Trust 1997
(<http://www.fieldfare.org.uk/public.htm>)

Inclusive Projects: a guide to best practice on
preparing and delivering project briefs to secure
access DPTAC 2003 (<http://www.dptac.gov.uk>)

Meeting Part M and Designing Lifetime Homes:
Joseph Rowntree Foundation 1999
(<http://www.jrf.org.uk>)

Sign Design Guide: a guide to inclusive signage JMU
and the Sign Design Society 2000
(<http://www.jmuaccess.org.uk>)

16 Glossary

Unitary Development Plan (UDP) Saved Policies (September 2007)

UDP's set out the strategic and local framework for guiding future development in the borough. The document contains planning policies and provides guidance for the development of land and transport in the Borough.

Local Development Framework (LDF)

Under the new Planning and Compulsory Purchase Act, every Council is required to introduce a new Local Development Framework (LDF) for its planning policies. The LDF will replace UDP's.

Supplementary Planning Document

The Local Development Framework will be comprised of local development documents, which include Development Plan Documents that are part of the statutory development plan and Supplementary Planning Documents, which expand policies set out in a Development Plan Document, or provide additional detail.

Access Statement

An Access Statement enables the developer/applicant to explain the constraints of the scheme and the solutions introduced to provide a satisfactory outcome.

Design Statement

A Design Statement demonstrates how the principles of design have been incorporated within proposals, will illustrate their impacts and explain why the design has been considered.